

# Immagina **WOOD**



IMMAGINA AMPLIA LA PROPRIA GAMMA DI ANTE  
AD APERTURA A GOLA INSERENDO NELLA COLLEZIONE  
LUX TRE PROFILI :

“CURVO”, “AD ELLE”, “INCLINATO”.

TUTTI GARANTISCONO LA MASSIMA PERSONALIZZAZIONE  
DI COLORI E FINITURE CON INFINITE POSSIBILITÀ  
DI ABBINAMENTO.

IMMAGINA EXTENDS ITS RANGE OF FINGER RAIL  
OPENING DOORS INCLUDING IN THE LUX COLLECTION  
THREE PROFILES: “CURVED”, “L-SHAPED”, “INCLINED”.  
THEY PROVIDE THE MAXIMUM CUSTOMIZATION  
FOR COLORS AND FINISHES, WITH ENDLESS MATCHING  
POSSIBILITIES.

# Immagina **Wood**

# LUX

anta con tre nuovi profili  
e maniglia a gola  
door with three new profiles  
and finger-rail





LA GOLA DELLE BASI E DELLE COLONNE PUÒ ESSERE IN DIVERSI COLORI LACCATI O IN ALLUMINIO FINITURA BRILL PER CREARE GIOCHI DI CROMIE E DARE UN DETTAGLIO PARTICOLARE ALLA PROPRIA CUCINA.

BASE UNITS AND COLUMNS FINGER RAILS ARE AVAILABLE IN VARIOUS LACQUERED COLOURS OR IN ALUMINIUM VERSION WITH BRILL FINISH, TO CREATE COLOUR EFFECTS AND ADD A DISTINCTIVE NOTE TO THE KITCHEN.

# Immagina **wood** Neck

anta con maniglia a gola  
door with finger-rail handle



NUOVE MANIGLIE CON FINITURA CROMATA,  
FINITURA ACCIAIO SATINATO E OSSIDATO,  
PER UN'ANTA DAL CARATTERE DECISO.

NEW HANDLES WITH CHROME,  
OR SATIN STEEL AND OXIDIZED FINISH,  
FOR A DOOR WITH DECIDED CHARACTER.

Immagina **wood**

# Bridge

anta con maniglia frontale  
door with front handle



È UNA NUOVA MANIGLIA IN ALLUMINIO  
CHE GARANTISCE UN'OTTIMA PRESA.  
IL DESIGN È ESTREMAMENTE PULITO.

A NEW ALUMINIUM HANDLE  
FOR A GOOD GRIP.  
THE DESIGN IS VERY CLEAN.

# Immagina **wood** Head

anta con maniglia applicata in testa  
door with top-mounted handle





SP. 22 MM

## CARATTERISTICHE TECNICHE

### ANTE E FRONTALI CASSETTI

anta sp.22 mm costituita da un pannello di particelle di legno (conforme **US EPA TSCA Title VI**) impiallacciato rovere tinto a poro aperto fiamma verticale \* **WOOD** con bordo polipropilene\* 10/10 in tinta nei colori : rovere moscato (opz.5444), rovere fumè (opz.5445), rovere grey (opz.5443), rovere naturale (opz.5442)

anta sp.22 mm costituita da un pannello di particelle di legno (conforme **US EPA TSCA Title VI**) impiallacciato rovere laccato a poro aperto fiamma verticale \* **WOOD** con bordo polipropilene\* 10/10 in tinta nei colori : rovere bianco (opz.5441), rovere nero (opz.5446)

\* **WOOD** proprietà tecniche:

**Le ante impiallacciate WOOD sono costituite da un pannello di particelle di legno impiallacciato rovere sottoposto a un processo di verniciatura trasparente attraverso la tecnologia "ECCIMERI". Tale trattamento conferisce alle ante una superficie ULTRA OPACA (circa 5 gloss), con effetto SOFT-TOUCH e una maggiore resistenza al graffio.**

**La parte posteriore dell'anta non è soggetta al trattamento sopraindicato, viene rivestita con impiallaccio in tinta ma con caratteristiche differenti rispetto al frontale.**



\* Tecnologia produttiva di elevata qualità trasmette al bordo un'alta resistenza ai prodotti acidi, solventi e raggi UV. Inoltre è un prodotto ecologico

### STRUTTURE

**ANTA:** rovere bianco

di serie : nobilitato bianco (opz.001) schiena e ripiano bianco (opz.001)

**ANTE:** rovere naturale, rovere grey, rovere moscato

di serie : nobilitato visone (opz.948M) schiena e ripiano visone (opz.948M)

**ANTE:** rovere fumè, rovere nero

di serie : nobilitato lavagna (opz.9620) schiena e ripiano lavagna (opz.9620)

### PROFILI E GOLE VERSIONE LUX

di serie: profilo curvo brill (opz.PC412), per gola piatta brill (opz.412P)

a richiesta: profilo curvo per gola ad "ELLE"



a richiesta: profilo ad elle per gola piatta  
profilo ad elle per gola ad "ELLE"



a richiesta: profilo inclinato per gola piatta  
profilo inclinato per gola "ELLE"



### PROFILO E GOLA VERSIONE NECK

anta squadrata senza profilo con gola "ELLE"



**N.B.:** per le finiture profili e gole vedi pag.17

### MANIGLIE

vedi pag.26-35

### MENSOLE COME STRUTTURE

vedi pag.36

### MENSOLE COME ANTE

vedi pag.36

### ZOCCOLI

vedi pag.37

## TECHNICAL FEATURES

### DOORS AND DRAWER FRONTS

22 mm th. door made of a panel in open-pore of vertical flame stained oak veneered wood particles (US EPA TSCA Title VI compliant) **\* WOOD** with 10/10 polypropylene\* edge available in the following colours:  
muscat oak (opt. 5444), smoked oak (opt. 5445), grey oak (opt. 5443), natural oak (opt. 5442)

22 mm th. door made of a panel in open-pore of vertical flame lacquered oak veneered wood particles (US EPA TSCA Title VI compliant) **\* WOOD** with 10/10 polypropylene\* edge available in the following colours:  
white oak (opt. 5441), black oak (opt. 5446)

**\* WOOD** technical specifications:

The **WOOD** veneered door is a panel of oak veneered wood particles subjected to a transparent painting process using the “**ECCIMERI**” technology.

This treatment gives the doors an **ULTRA MATT** surface (about 5 gloss), with a **SOFT-TOUCH** effect and a greater scratch resistance.

The rear part of the door is not subject to the above treatment, it is covered with matching veneer wood that has different characteristics than the front.



**\* High quality manufacturing technology, gives the edging a high level of resistance to acids, solvents and UV rays. It is also an ecological product.**

### CARCASSES

**DOOR: white oak**

standard: melamine-coated white (opt.001), white back panel and shelf (opt.001)

**DOORS: natural oak, gray oak, muscat oak**

standard: melamine-coated mink (opt.948M), mink back panel and shelf (opt.948M)

**DOORS: smoked oak, black oak**

standard: melamine-coated slate grey (opt.9620) back panel and shelf slate grey (opt.9620)

### PROFILES AND FINGER RAILS LUX VERSION

**standard: brill curved profile (opt.PC412), for flat finger rail brill (opt.412P)**  
on request: curved profile for “L” shaped finger rail



on request: L shaped profile for flat finger rail  
L shaped profile for “L” shaped finger rail



on request: inclined profile for flat finger rail  
inclined profile “L” shaped finger rail



### PROFILE AND FINGER RAIL NECK VERSION

square door without profile with “L” shaped finger rail

**NOTE: for the profile and finger rail finishes see page 17**



### HANDLES

see page 26-35

### SHELVES WITH CARCASSES

see page 36

### SHELVES WITH DOORS

see page 36

### PLINTHS

see page 37

# Impiallacciato Veneered

SP. 22 MM TH. 22 MM

---

Lux  
Neck  
Bridge  
Head

ante finitura impiallacciata rovere tinto a poro aperto  
doors with open pore stained oak veneered finish

 *colori in pronta consegna  
available colours*



rovere naturale (opz.5442),  
fiamma verticale  
natural oak (opt.5442),  
vertical grain



rovere grey (opz.5443),  
fiamma verticale  
grey oak (opt.5443),  
vertical grain



rovere moscato (opz.5444),  
fiamma verticale  
muscat oak (opt.5444),  
vertical grain



rovere fumè (opz.5445),  
fiamma verticale  
smoked oak (opt.5445),  
vertical grain



# Impiallacciato Veneered

SP. 22 MM TH. 22 MM

---

Lux  
Neck  
Bridge  
Head

ante finitura impiallacciata rovere laccato a poro aperto  
doors with open pore lacquered veneered finish

 *colori in pronta consegna  
available colours*



rovere bianco (opz.5441),  
fiamma verticale  
white oak (opt.5441),  
vertical grain



rovere nero (opz.5446),  
fiamma verticale  
black oak (opt.5446),  
vertical grain

## Telaio alluminio

Aluminium frame

---

**di serie:** telaio alluminio titanio sp.22 mm vetro satinato, bronzo o fumè

**standard:** 22 mm th. titanium aluminium frame satin, bronze or fumè glass



telaio titanio con vetro satinato  
(opz.TISAT)  
titanium frame with satin glass  
(opt.TISAT)



telaio titanio con vetro bronzo  
(opz.TIBRZ)  
titanium frame with bronze glass  
(opt.TIBRZ)



telaio titanio con vetro fumè  
(opz.TIFUM)  
titanium frame with fumè glass  
(opt.TIFUM)

**a richiesta :** telaio alluminio verniciato urban sp.22 mm vetro satinato, bronzo o fumè

**on request:** 22 mm th. urban painted aluminium frame satin, bronze or fumè glass



telaio urban con vetro satinato  
(opz.GISAT)  
urban frame with satin glass  
(opt.GISAT)



telaio urban con vetro bronzo  
(opz.GIBRZ)  
urban frame with bronze glass  
(opt.GIBRZ)



telaio urban con vetro fumè  
(opz.GIFUM)  
urban frame with fumè glass  
(opt.GIFUM)

# Vetro Glass

## Telaio alluminio

Aluminium frame

**a richiesta :** telaio alluminio verniciato silver dark sp.22 mm vetro satinato, bronzo o fumè

**on request:** 22 mm th. silver dark painted aluminium frame satin, bronze or fumè glass



telaio silver dark con vetro satinato  
(opz.PISAT)  
silver dark frame with satin glass  
(opt.PISAT)



telaio silver dark con vetro bronzo  
(opz.PIBRZ)  
silver dark frame with bronze glass  
(opt.PIBRZ)



telaio silver dark con vetro fumè  
(opz.PIFUM)  
silver dark frame with fumè glass  
(opt.PIFUM)



particolare maniglia incassata  
sul traverso per ante con apertura  
a ribalta, pacchetto e verticale obliqua  
low frame build-in handle detail, for flap,  
lift-up folding and oblique vertical  
opening doors

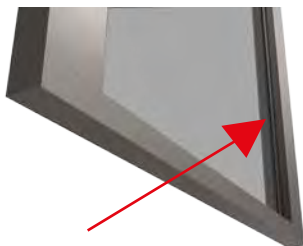

particolare presa su interno  
montante per ante battenti  
internal grip handle detail,  
for hinged doors

**SP. 22 MM TH. 22 MM**

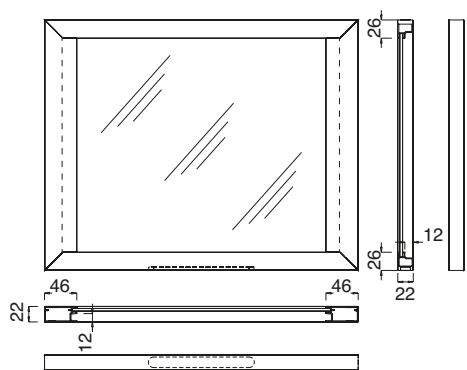

**SP. 22 MM TH. 22 MM**

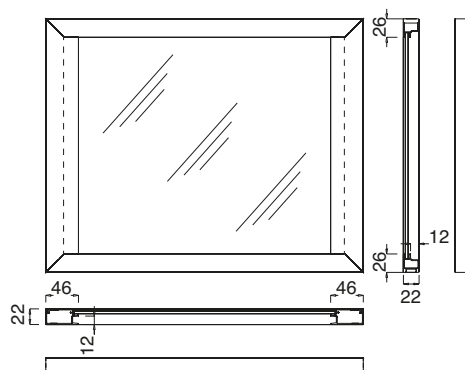



# APERTURA CON GOLLA OPENING BY FINGER RAIL

LUX

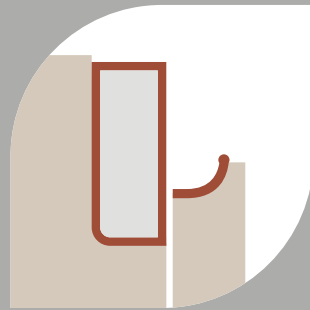

GOLA PIATTA  
FLAT FINGER RAIL



GOLA TIPO "ELLE"  
"ELLE" TYPE FINGER RAIL

ANTA CON  
PROFILO CURVO  
(OPZ. P C + COD. COLORE)  
DOOR WITH CURVED PROFILE

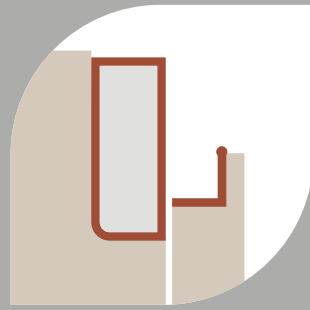

GOLA PIATTA  
FLAT FINGER RAIL

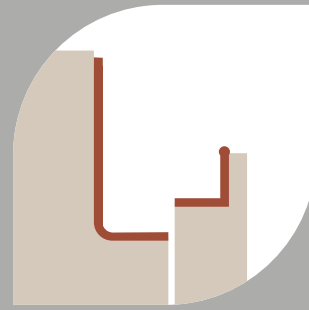

GOLA TIPO "ELLE"  
"ELLE" TYPE FINGER RAIL

ANTA CON  
PROFILO AD "ELLE"  
(OPZ. P L + COD. COLORE)  
DOOR WITH "ELLE" SHAPED PROFILE

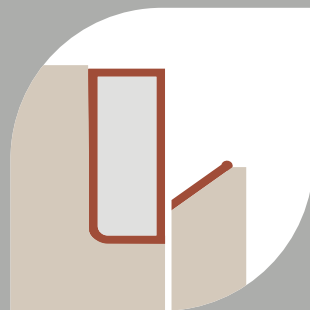

GOLA PIATTA  
FLAT FINGER RAIL



GOLA TIPO "ELLE"  
"ELLE" TYPE FINGER RAIL

ANTA CON  
PROFILO INCLINATO  
(OPZ. P I + COD. COLORE)  
DOOR WITH INCLINED PROFILE

Neck



GOLA TIPO "ELLE"  
"ELLE" TYPE FINGER RAIL

ANTA **NECK**  
PER GOLA TIPO "ELLE"  
"NECK" DOOR FOR "ELLE" TYPE  
FINGER RAIL

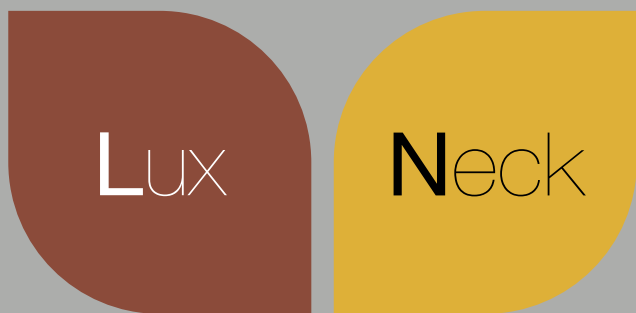

# FINITURE PROFILI E GOLE

## FINITURE PROFILI E GOLE SPAZZOLATI FINGER RAILS AND PROFILES BRUSHED FINISHES





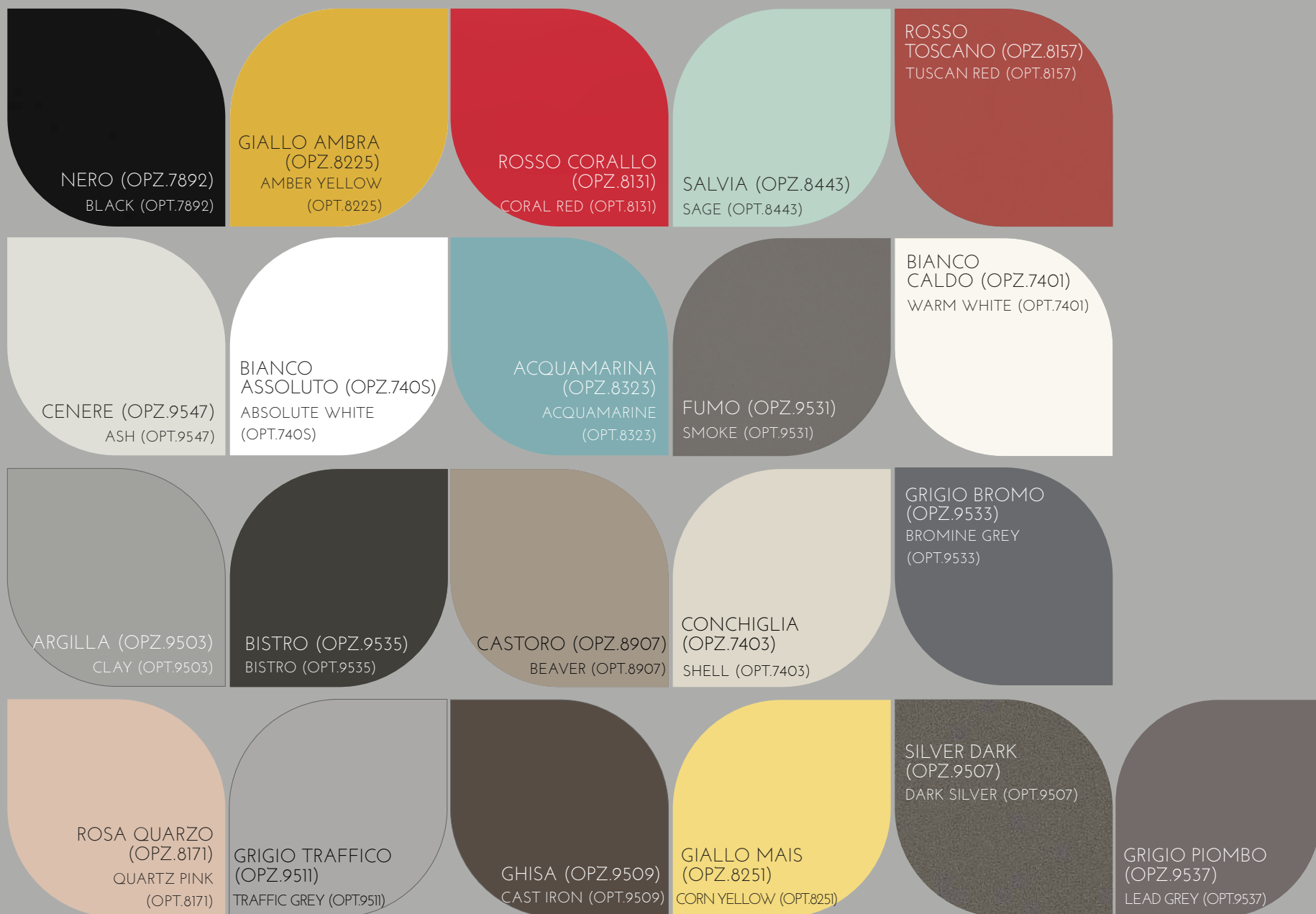

## FINITURE PROFILI E GOLE VERNICIATI A POLVERE OPACHI MATT FINGER RAILS AND PROFILES POWDER COATED FINISHES



# GOLA PIATTA ORIZZONTALE SOTTOTOP

UNDERMOUNT HORIZONTAL **FLAT** FINGER RAIL

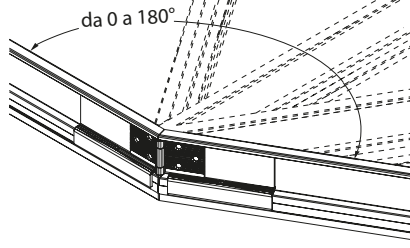
	COD.			COD.	
<p><b>Gola piatta sottotop tipo "AP"</b> Type "AP" undermount flat finger rail</p> 				<p><b>Angolo interno a 90° per gola tipo "AP"</b> 90° interior corner for "AP" type finger rail</p> 	
	al ml per lm	G960010		cadauno each	G960050
<p><b>Terminale chiuso "T1" dx o sx per gola tipo "AP" da utilizzare a fine composizione</b> "T1" RH or LH closure for type "AP" finger rail to be placed at the end of the composition</p> 				<p><b>Angolare con snodo per unione fuori squadra per gola tipo "AP"</b> Corner piece with joint for out-of-plumb joining for type "AP" finger rail</p> 	
	<b>terminale DX</b> RH end	G960021			
	<b>terminale SX</b> LH end	G960022			
<p><b>Terminale chiuso "T2" dx o sx per gola tipo "AP" da utilizzare solo tra basi e colonne</b> "T2" RH or LH closure for type "AP" finger rail to be placed only between base units and column</p> 					
	<b>terminale DX</b> RH end	G960031			
	<b>terminale SX</b> LH end	G960032			
					G950060









# GOLA PIATTA ORIZZONTALE INTERMEDIA

INTERMEDIATE HORIZONTAL **FLAT** FINGER RAIL

# GOLE VERTICALI PIATTE PER COLONNE

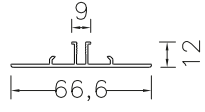
VERTICAL **FLAT** FINGER RAILS FOR COLUMNS

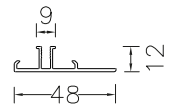
	COD.					
 <p><b>Gola piatta intermedia tipo "BP"</b> Type "BP" intermediate flat finger rail</p>						
	al ml per lm	G960110				
 <p><b>Terminale chiuso "T3" dx o sx per gola tipo "BP" da utilizzare a fine composizione</b> "T3" RH or LH closure for type "BP" finger rail to be placed at the end of the composition</p>						
	<b>terminale DX</b> RH end	G960121				
	<b>terminale SX</b> LH end	G960122				
 <p><b>Terminale chiuso "T4" dx o sx per gola tipo "BP" da utilizzare solo tra cassettiere e lavastoviglie/colonne</b> "T4" RH or LH closure for type "BP" finger rail To be placed only between drawer units and dishwasher/columns</p>						
	<b>terminale DX</b> RH end	G960131				
	<b>terminale SX</b> LH end	G960132				
 <p><b>Gola verticale piatta intermedia tipo "DP" (completa di distanziale)</b> Type "DP" intermediate vertical flat finger rail (complete with spacer)</p>  <p><b>Sezione gola tipo "DP"</b> Cross section of type "DP" finger rail</p>						
				<b>Piedi H 13</b> H 96	G960410	
				H 132	G960430	
				H 204	G960450	
				H 228	G960470	
				<b>Piedi H 6</b> H 108	G960420	
				H 144	G960440	
				H 216	G960460	
 <p><b>Gola verticale piatta laterale tipo "CP" (completa di distanziale)</b> Type "CP" vertical side flat finger rail (complete with spacer)</p>  <p><b>Sezione gola tipo "CP"</b> Cross section of type "CP" finger rail</p>						
				<b>Piedi H 13</b> H 96	G960310	
				H 132	G960330	
				H 204	G960350	
				H 228	G960370	
				<b>Piedi H 6</b> H 108	G960320	
				H 144	G960340	
				H 216	G960360	

# NOZIONI UTILI - gole orizzontali **piatte** per basi

USEFUL INFORMATION - HORIZONTAL **FLAT** FINGER RAILS FOR BASE UNITS

## VISTA FRONTALE ZOCCOLO H 13 PER BASI H 88

FRONT VIEW PLINTH H 13 FOR BASE UNITS H 88

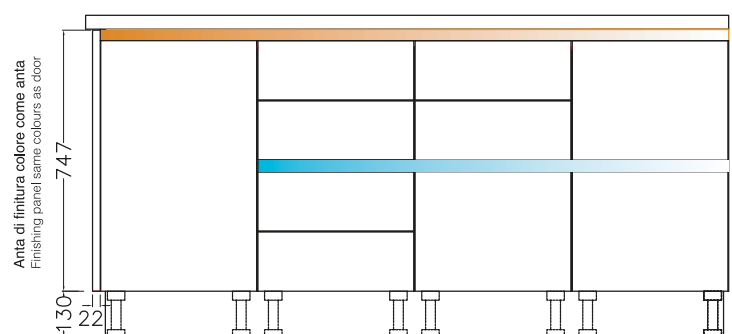
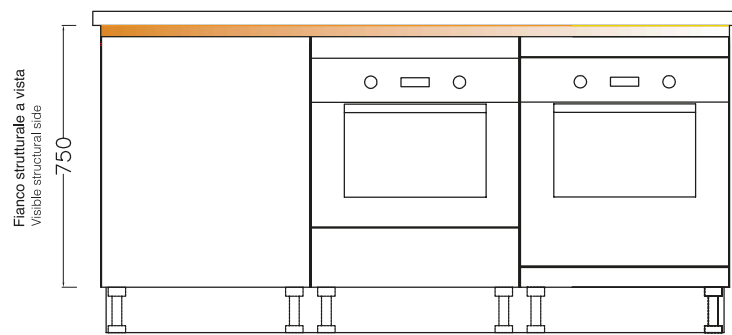

## VISTA FRONTALE ZOCCOLO H 6 PER BASI H 90

FRONT VIEW PLINTH H 6 FOR BASE UNITS H 90

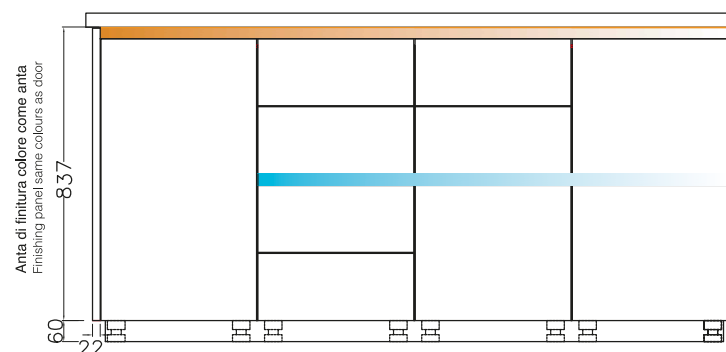
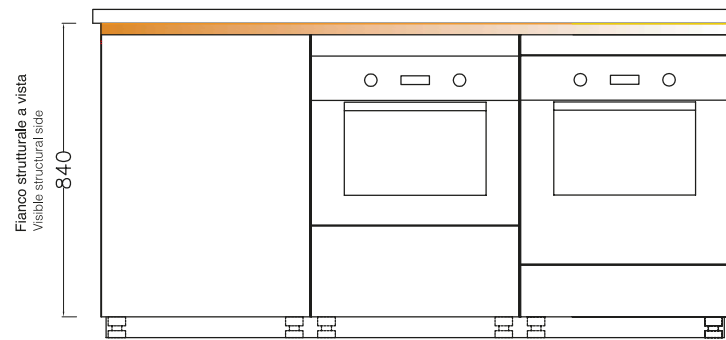

## VISTA LATERALE (sezione) ZOCCOLO H 13 PER BASI H 88

SIDE VIEW (CROSS SECTION) PLINTH H 13 FOR BASE UNITS H 88

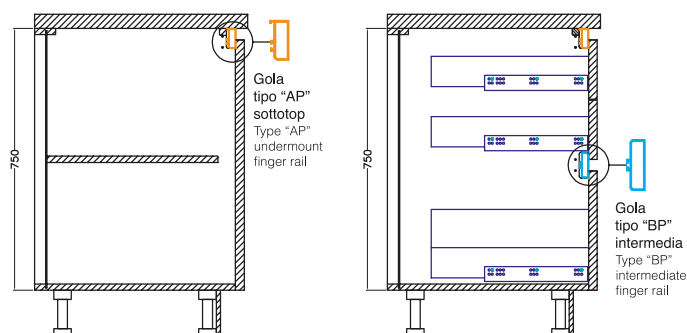

## VISTA LATERALE (sezione) ZOCCOLO H 6 PER BASI H 90

SIDE VIEW (CROSS SECTION) PLINTH H 6 FOR BASE UNITS H 90

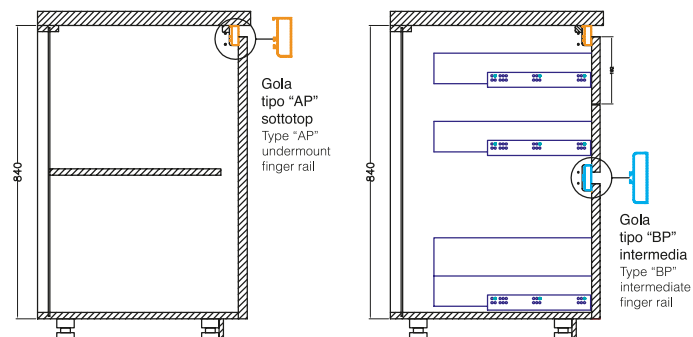

## VISTA DALL'ALTO

TOP VIEW

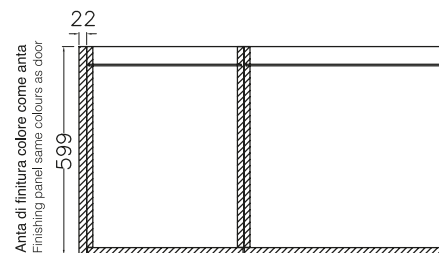
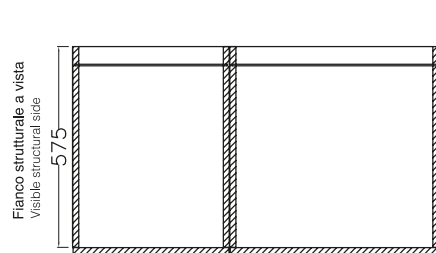

Composizione con ante di finitura laterali: alla dimensione finale della cucina, sommare sempre lo spessore delle ante di finitura (ogni anta sempre 2,2 cm)

Composition with side finishing panels: to the final size of the kitchen, always add the thickness of the finishing panels (each panel 22 mm)

# NOZIONI UTILI - gole verticali **piatte** per colonne

USEFUL INFORMATION - VERTICAL **FLAT** FINGER RAILS FOR COLUMNS

## VISTA FRONTALE ZOCCOLO H 13

FRONT VIEW PLINTH H 13

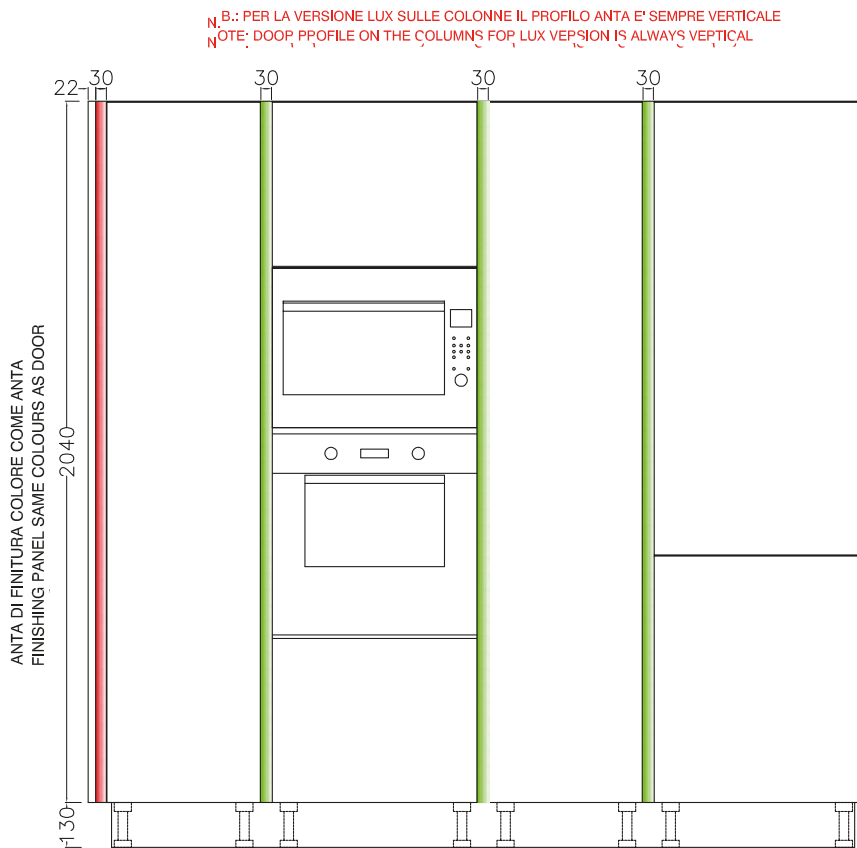

## VISTA FRONTALE ZOCCOLO H 6

FRONT VIEW PLINTH H 6

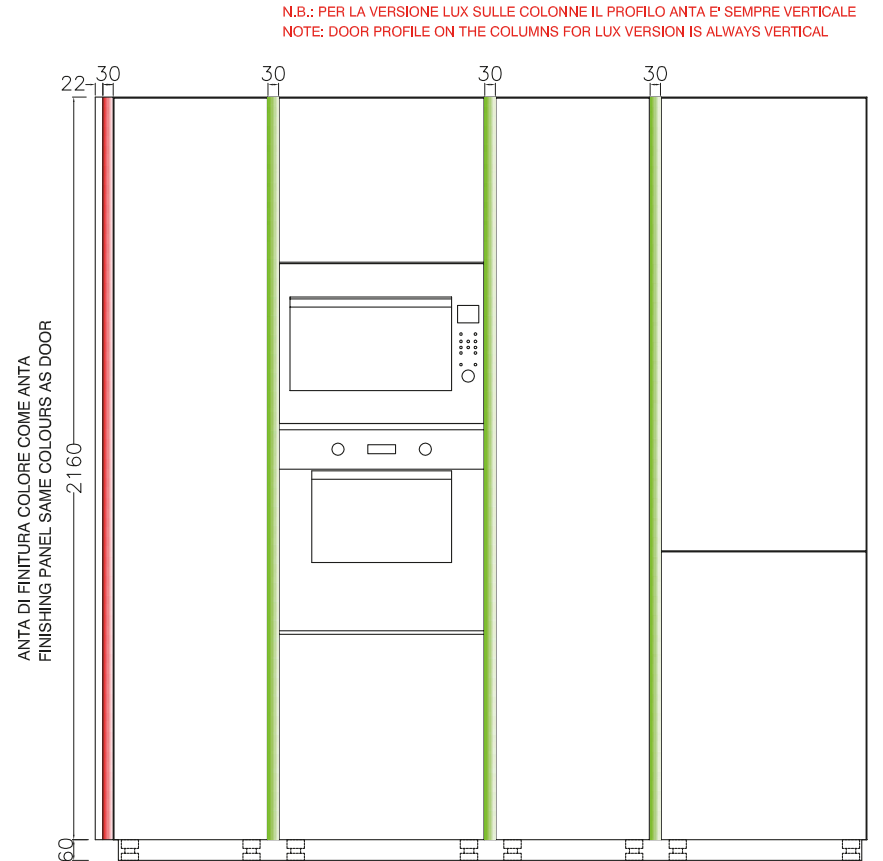

## VISTA DALL'ALTO

TOP VIEW

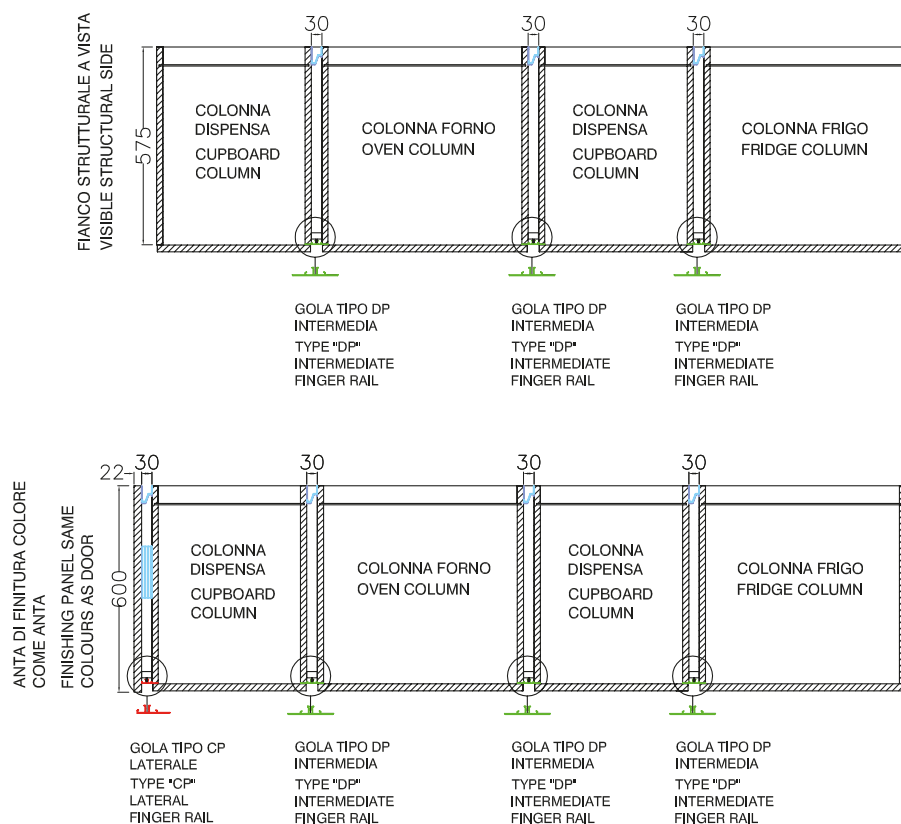

Composizione fianco strutturale  
a vista come anta:  
alla dimensione finale della cucina,  
sommare sempre lo spessore dei  
distanziali tra le colonne  
(ogni distanziale 3 cm)









Composition with visible side panel to match door:  
to the final size of the kitchen, always add the thickness  
of the spacers between the two columns (each spacer 3 cm)

Composizione con ante di finitura  
laterali, alla dimensione finale della  
cucina, sommare sempre lo spessore  
dei distanziali tra le colonne  
(ogni distanziale 3 cm) e lo spessore  
delle ante di finitura (ogni anta 2,2 mm)

Composition with side finishing panels to the final size of the  
kitchen, always add the thickness of the spacer between the  
two columns (each spacer 3 cm) and the thickness of the  
finishing panels (each panel 2,2 mm)

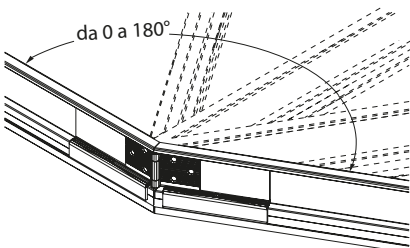
# GOLA "ELLE" ORIZZONTALE SOTTOTOP

UNDERMOUNT HORIZONTAL "ELLE" FINGER RAIL









	COD.			COD.		
<p><b>Gola sottotop tipo "A"</b> Type "A" undermount finger rail</p>  <p style="text-align: right;"><b>al ml</b> per lm</p>	G950010			<p><b>Angolo interno a 90° per gola tipo "A"</b> 90° interior corner for "A" type finger rail</p>  <p style="text-align: right;"><b>cadauno</b> each</p>	G950050	
<p><b>Terminale aperto dx o sx per gola tipo "A" da utilizzare a fine composizione</b> RH or LH open end for type "A" finger rail to be placed at the end of the composition</p>  <p style="text-align: right;"><b>terminale DX</b> RH end <b>terminale SX</b> LH end</p>	G950021			<p><b>Angolare con snodo per unione fuori squadra per gola tipo "A"</b> Corner piece with joint for out-of-plumb joining for type "A" finger rail</p>   <p style="text-align: right;">da 0 a 180°</p>		
<p><b>Terminale chiuso dx o sx per gola tipo "A" da utilizzare solo tra basi e colonne</b> RH or LH closure for type "A" finger rail to be placed only between base units and column</p>  <p style="text-align: right;"><b>terminale DX</b> RH end <b>terminale SX</b> LH end</p>	G950031					
<p><b>Terminale chiuso dx o sx per gola tipo "A" da utilizzare solo tra basi e colonne</b> RH or LH closure for type "A" finger rail to be placed only between base units and column</p>  <p style="text-align: right;"><b>terminale DX</b> RH end <b>terminale SX</b> LH end</p>	G950032					G950060
<p><b>Coppia angolari per kit raccordo base angolo 110x110</b> Couple corner piece for fitting kit corner base unit 110x110</p>  <p style="text-align: center;">SX LH                      DX RH</p> <p style="text-align: right;"><b>in alluminio</b> aluminium <b>angolare DX</b> RH corner piece <b>angolare SX</b> LH corner piece</p>	G950058					
	G950059					

# GOLA "ELLE" ORIZZONTALE INTERMEDIA

INTERMEDIATE HORIZONTAL "ELLE" FINGER RAIL

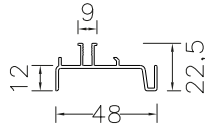
# GOLE "ELLE" VERTICALI PER COLONNE

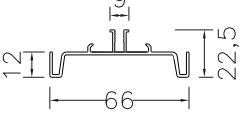
VERTICAL "ELLE" FINGER RAILS FOR COLUMNS

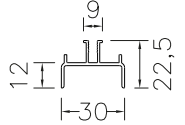
	COD.			COD.	
<p><b>Gola intermedia tipo "B"</b></p> <p>Type "B" intermediate finger rail</p> 					
	al ml per lm	G950110			
<p><b>Terminale aperto dx o sx per gola tipo "B" da utilizzare a fine composizione</b></p> <p>RH or LH open end for type "B" finger rail to be placed at the end of the composition</p> 					
	terminale DX RH end	G950121			
terminale SX LH end	G950122				
<p><b>Terminale chiuso dx o sx per gola tipo "B" da utilizzare solo tra cassettiere e lavastoviglie/colonne</b></p> <p>RH or LH closure for type "B" finger rail to be placed only between drawer units and dishwasher/columns</p> 					
	terminale DX RH end	G950131			
terminale SX LH end	G950132				
<p><b>Mezza gola verticale tipo "C" (completa di distanziale)</b></p> <p>Type "C" half vertical finger rail (complete with spacer)</p>   <p>sezione mezza gola tipo "C" cross section of type "C" finger rail</p>					
	Piedi H 13 H 96 H 132 H 204 H 228	G950310 G950330 G950350 G950370			
Piedi H 6 H 108 H 144 H 216	G950320 G950340 G950360				
<p><b>Gola verticale intermedia tipo "D" (completa di distanziale)</b></p> <p>Type "D" intermediate vertical finger rail (complete with spacer)</p>   <p>sezione gola tipo "D" cross section of type "D" finger rail</p>					
	Piedi H 13 H 96 H 132 H 204 H 228	G950410 G950430 G950450 G950470			
Piedi H 6 H 108 H 144 H 216	G950420 G950440 G950460				
<p><b>Gola verticale laterale tipo "E" (completa di distanziale)</b></p> <p>Type "E" lateral vertical finger rail (complete with spacer)</p>   <p>sezione gola tipo "E" cross section of type "E" finger rail</p>					
	Piedi H 13 H 96 H 132 H 204 H 228	G950510 G950530 G950550 G950570			
Piedi H 6 H 108 H 144 H 216	G950520 G950540 G950560				



# NOZIONI UTILI - gole "elle" orizzontali per basi

USEFUL INFORMATION - HORIZONTAL "ELLE" FINGER RAILS FOR BASE UNITS

## VISTA FRONTALE ZOCCOLO H 13 PER BASI H 88

FRONT VIEW PLINTH H 13 FOR BASE UNITS H 88

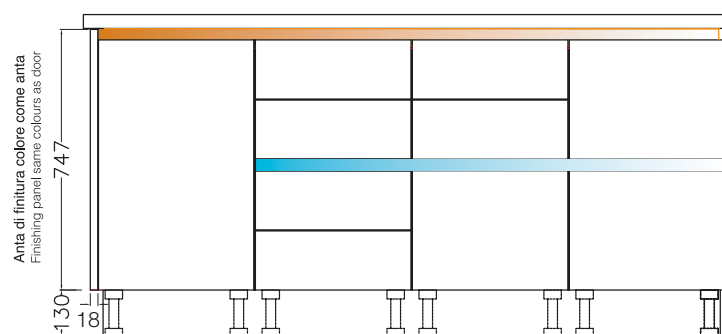
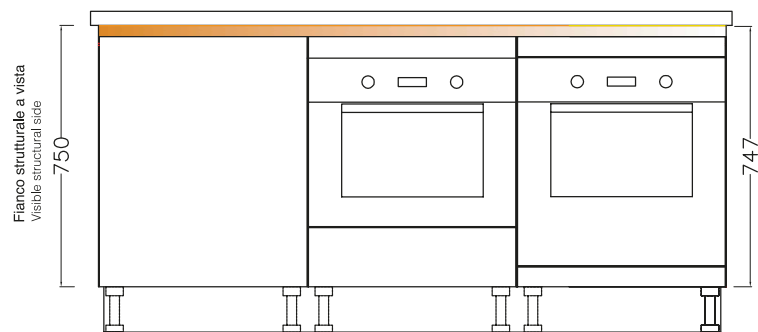

## VISTA FRONTALE ZOCCOLO H 6 PER BASI H 90

FRONT VIEW PLINTH H 6 FOR BASE UNITS H 90

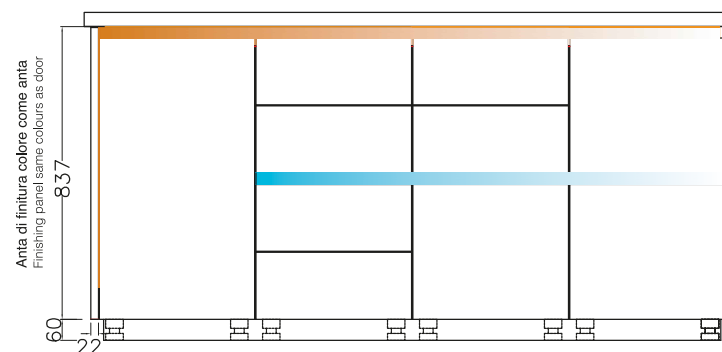
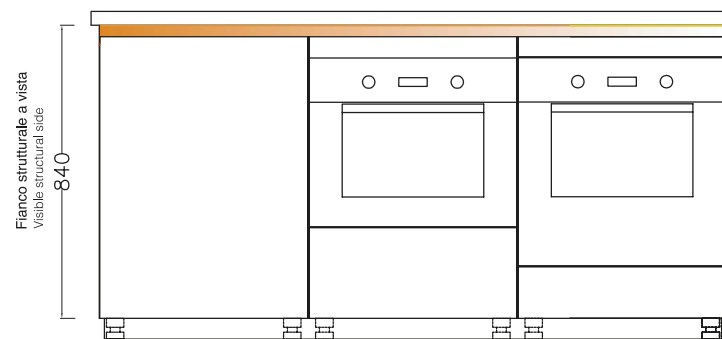

## VISTA LATERALE (sezione) ZOCCOLO H 13 PER BASI H 88

SIDE VIEW (CROSS SECTION) PLINTH H 13 FOR BASE UNITS H 88

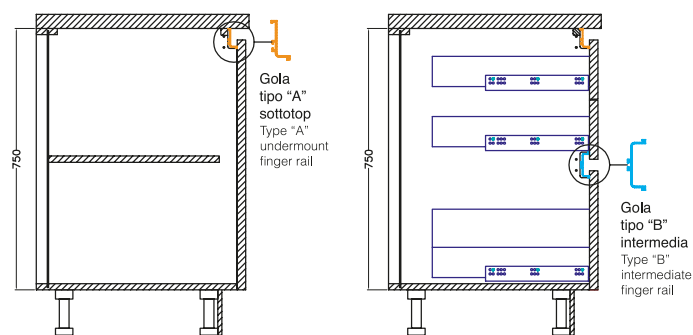

## VISTA LATERALE (sezione) ZOCCOLO H 6 PER BASI H 90

SIDE VIEW (CROSS SECTION) PLINTH H 6 FOR BASE UNITS H 90

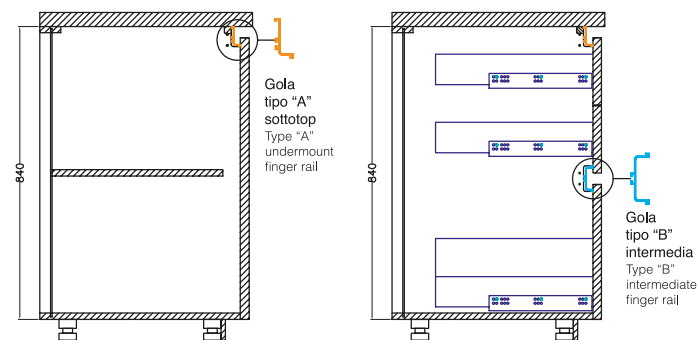

## VISTA DALL'ALTO

TOP VIEW

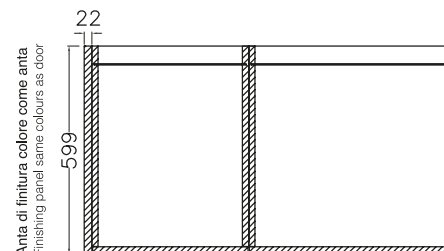
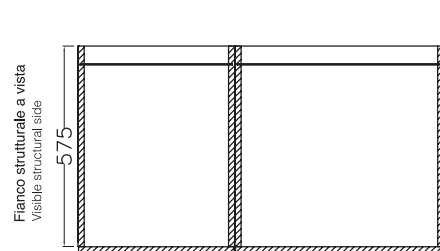

Composizione con ante di finitura laterali: alla dimensione finale della cucina, sommare sempre lo spessore delle ante di finitura (ogni anta sempre 2,2 cm)

Composition with side finishing panels: to the final size of the kitchen, always add the thickness of the finishing panels (each panel 22 mm)

# NOZIONI UTILI - gole "elle" verticali per colonne

USEFUL INFORMATION - VERTICAL "ELLE" FINGER RAILS FOR COLUMNS

## VISTA FRONTALE ZOCCOLO H 13

FRONT VIEW PLINTH H 13

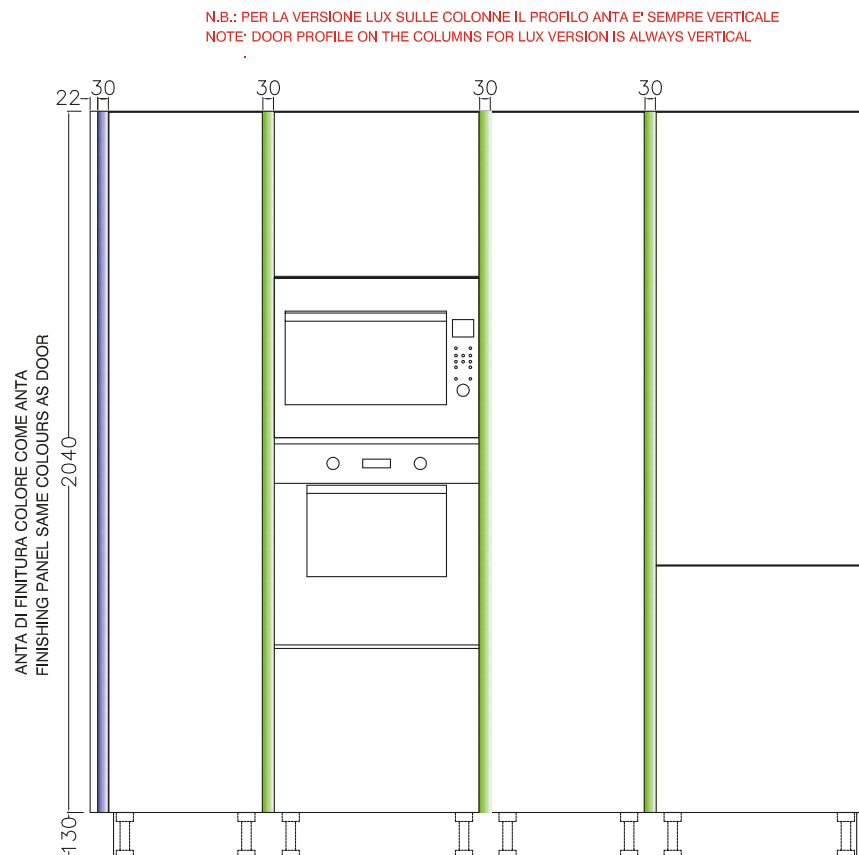

## VISTA FRONTALE ZOCCOLO H 6

FRONT VIEW PLINTH H 6

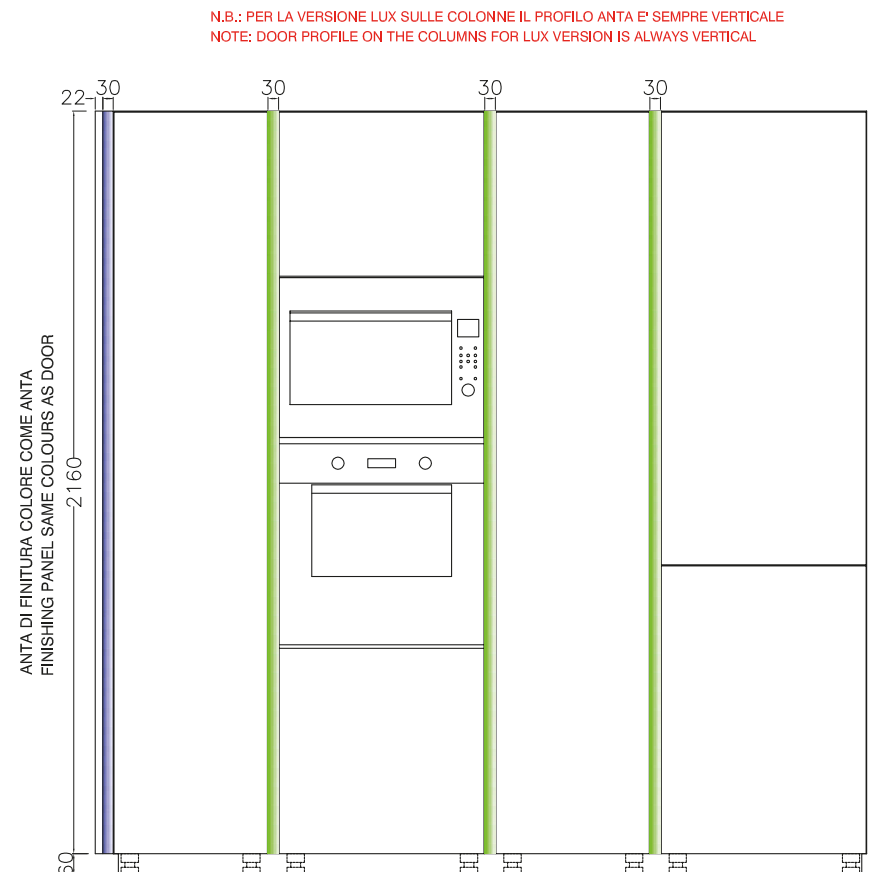

## VISTA DALL'ALTO

TOP VIEW

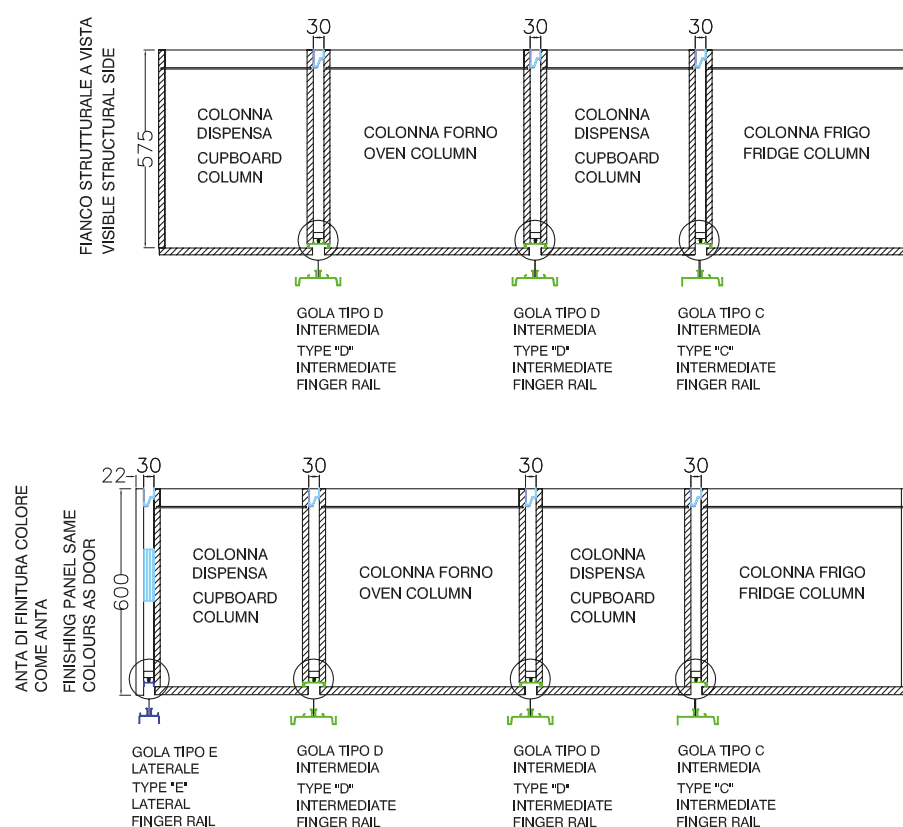

Composizione fianco strutturale  
a vista come anta:  
alla dimensione finale della cucina,  
sommare sempre lo spessore dei  
distanziali tra le colonne  
(ogni distanziale 3 cm)

Composition with visible side panel to match door:  
to the final size of the kitchen, always add the thickness  
of the spacers between the two columns (each spacer 3 cm)

Composizione con ante di finitura  
laterali, alla dimensione finale della  
cucina, sommare sempre lo spessore  
dei distanziali tra le colonne  
(ogni distanziale 3 cm) e lo spessore  
delle ante di finitura (ogni anta 2,2 cm)

Composition with side finishing panels to the final size of the  
kitchen, always add the thickness of the spacer between the  
two columns (each spacer 3 cm) and the thickness of the  
finishing panels (each panel 2,2 mm)

**DI SERIE STANDARD**



Maniglia 577N finitura nichel satinato  
 anta L 15 → passo 64 mm  
 anta da L 30 a L 45 → passo 160 mm  
 anta da L 60 a L 90 → passo 320 mm

Handle 577N satin nickel finish  
 door W 15 → centre-to-centre distance 64 mm  
 door from W 30 to W 45 → centre-to-centre distance 160 mm  
 door from W 60 to W 90 → centre-to-centre distance 320 mm



Maniglia 475S finitura nichel satinato  
 anta L 15 → passo 96 mm  
 anta da L 30 a L 45 → passo 160 mm  
 anta da L 60 a L 90 → passo 320 mm

Handle 475S satin nickel finish  
 door W 15 → centre-to-centre distance 96 mm  
 door from W 30 to W 45 → centre-to-centre distance 160 mm  
 door from W 60 to W 90 → centre-to-centre distance 320 mm



Maniglia 59G finitura ghisa  
 anta L 15 → passo 32 mm  
 anta L 30 a L 45 → passo 160 mm  
 anta da L 60 a L 90 → passo 448 mm

Handle 59G cast iron finish  
 door W 15 → centre-to-centre distance 32 mm  
 door W 30 to W 45 → centre-to-centre distance 160 mm  
 door from W 60 to W 90 → centre-to-centre distance 448 mm



Maniglia 567A finitura soft verniciata antracite  
 anta L 15 → passo 64 mm  
 anta da L 30 a L 45 → passo 160 mm  
 anta da L 60 a L 90 → passo 320 mm

Handle 567A coated soft anthracite finish  
 door W 15 → centre-to-centre distance 64 mm  
 door from W 30 to W 45 → centre-to-centre distance 160 mm  
 door from W 60 to W 90 → centre-to-centre distance 320 mm

**A RICHIESTA ON REQUEST**



Maniglia 60S finitura silver dark  
 anta L 15 → passo 96 mm  
 anta da L 30 a L 45 → passo 160 mm  
 anta da L 60 a L 90 → passo 320 mm

Handle 60S dark silver finish  
 door W 15 → centre-to-centre distance 96 mm  
 door from W 30 to W 45 → centre-to-centre distance 160 mm  
 door from W 60 to W 90 → centre-to-centre distance 320 mm



Maniglia 477 finitura cromo  
 anta L 15 → passo 64 mm  
 anta da L 30 a L 45 → passo 160 mm  
 anta da L 60 a L 90 → passo 320 mm

Handle 477 chrome finish  
 door W 15 → centre-to-centre distance 64 mm  
 door from W 30 to W 45 → centre-to-centre distance 160 mm  
 door from W 60 to W 90 → centre-to-centre distance 320 mm



Maniglia 59N finitura anodizzato nero  
 anta L 15 → passo 32 mm  
 anta L 30 a L 45 → passo 160 mm  
 anta da L 60 a L 90 → passo 448 mm

Handle 59N oxidized black finish  
 door W 15 → centre-to-centre distance 32 mm  
 door W 30 to W 45 → centre-to-centre distance 160 mm  
 door from W 60 to W 90 → centre-to-centre distance 448 mm



Maniglia 563T finitura cromo interno tortora  
 anta L 15 → passo 64 mm  
 anta da L 30 a L 45 → passo 160 mm  
 anta da L 60 a L 90 → passo 320 mm

Handle 563T chrome finish dove grey interior  
 door W 15 → centre-to-centre distance 64 mm  
 door from W 30 to W 45 → centre-to-centre distance 160 mm  
 door from W 60 to W 90 → centre-to-centre distance 320 mm



Maniglia 60V finitura visone  
 anta L 15 → passo 96 mm  
 anta da L 30 a L 45 → passo 160 mm  
 anta da L 60 a L 90 → passo 320 mm

Handle 60V mink finish  
 door W 15 → centre-to-centre distance 96 mm  
 door from W 30 to W 45 → centre-to-centre distance 160 mm  
 door from W 60 to W 90 → centre-to-centre distance 320 mm



Maniglia 551 finitura cromo  
 anta L 15 → passo 64 mm  
 anta da L 30 a L 45 → passo 160 mm  
 anta da L 60 a L 90 → passo 320 mm

Handle 551 chrome finish  
 door W 15 → centre-to-centre distance 64 mm  
 door from W 30 to W 45 → centre-to-centre distance 160 mm  
 door from W 60 to W 90 → centre-to-centre distance 320 mm



Maniglia 59S finitura anodizzato silver dark  
 anta L 15 → passo 32 mm  
 anta L 30 a L 45 → passo 160 mm  
 anta da L 60 a L 90 → passo 448 mm

Handle 59S oxidized dark silver finish  
 door W 15 → centre-to-centre distance 32 mm  
 door W 30 to W 45 → centre-to-centre distance 160 mm  
 door from W 60 to W 90 → centre-to-centre distance 448 mm

# MANIGLIE HANDLES

# Immagina **Wood** Bridge

## MANIGLIE AD INCASSO RECESSED HANDLES



Maniglia 947G ad incasso finitura verniciato ghisa  
 anta L 15 → dimensioni L 85  
 anta da L 30 a L 45 → dimensioni L 190  
 anta da L 60 a L 90 → dimensioni L 340  
 anta da H 203,7 a H 215,7 → dimensioni L 676

Handle 947G recessed cast iron painted finish  
 door W 15 → dimensions W 85  
 door from W 30 to W 45 → dimensions W 190  
 door from W 60 to W 90 → dimensions W 340  
 door from H 203,7 to H 215,7 → dimensions W 676



Maniglia 947T ad incasso finitura titanio  
 anta L 15 → dimensioni L 85  
 anta da L 30 a L 45 → dimensioni L 190  
 anta da L 60 a L 90 → dimensioni L 340  
 anta da H 203,7 a H 215,7 → dimensioni L 676

Handle 947T recessed titanium finish  
 door W 15 → dimensions W 85  
 door from W 30 to W 45 → dimensions W 190  
 door from W 60 to W 90 → dimensions W 340  
 door from H 203,7 to H 215,7 → dimensions W 676



Maniglia 947S ad incasso finitura silver dark  
 anta L 15 → dimensioni L 85  
 anta da L 30 a L 45 → dimensioni L 190  
 anta da L 60 a L 90 → dimensioni L 340  
 anta da H 203,7 a H 215,7 → dimensioni L 676

Handle 947S recessed dark silver finish  
 door W 15 → dimensions W 85  
 door from W 30 to W 45 → dimensions W 190  
 door from W 60 to W 90 → dimensions W 340  
 door from H 203,7 to H 215,7 → dimensions W 676

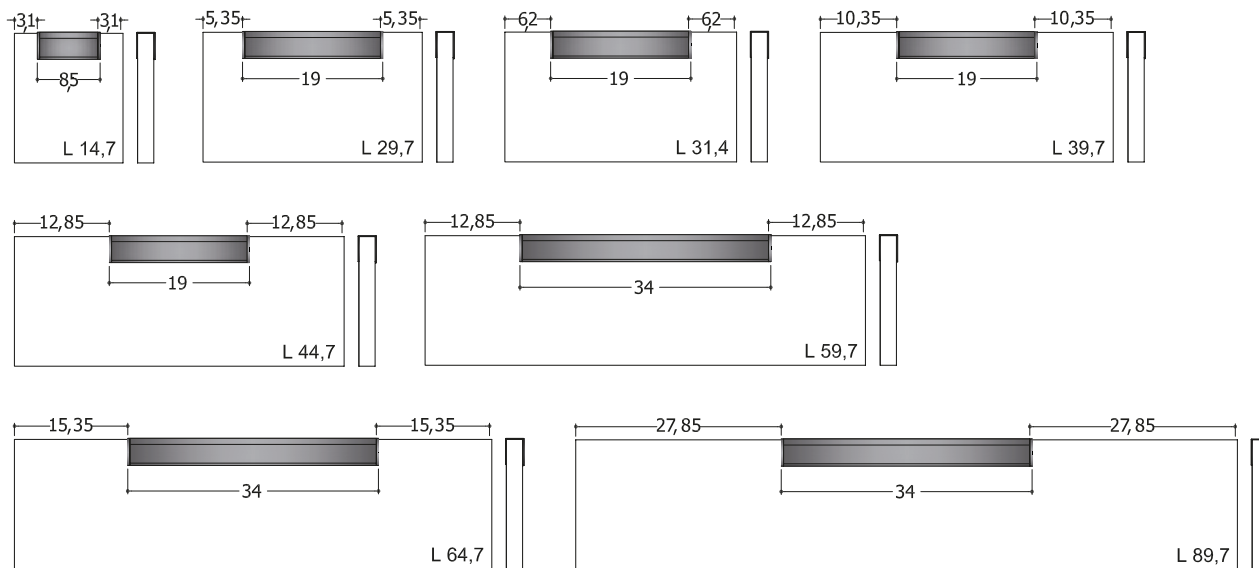

Anta monoporta con maniglia in verticale  
 Single-door with vertical handle

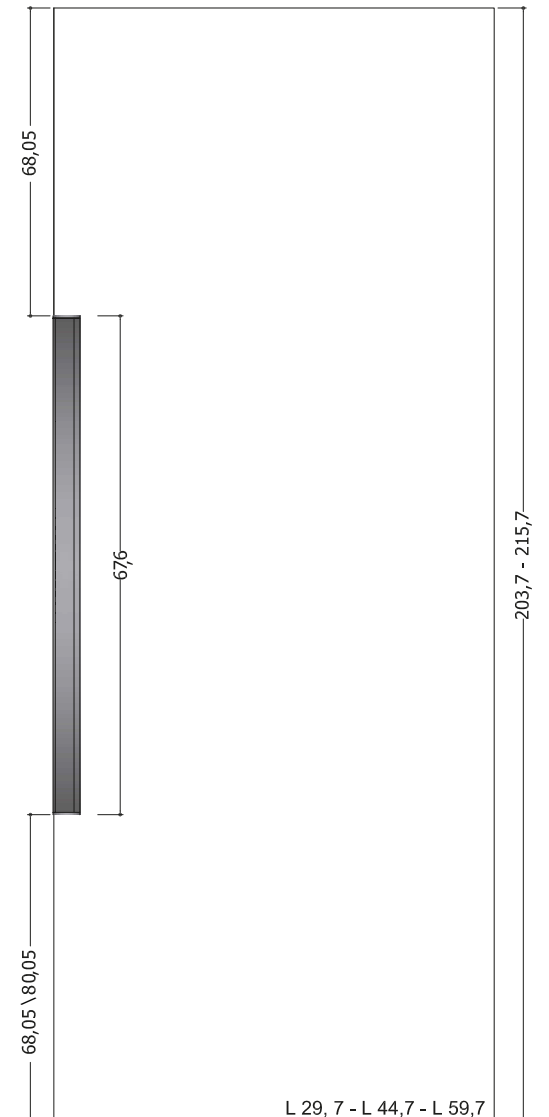

## MANIGLIA ORIZZONTALE HANDLE HORIZONTAL



Maniglia M40 finitura nero soft  
 passo in funzione dell'anta  
 Handle M40 soft black finish  
 centre-to-centre distance varies according to the door

per maniglie da L 78 a L 484 per  
 maniglia L 784  
 vedi schema tecnico



Maniglia M42 finitura nichel satinata  
 passo in funzione dell'anta  
 Handle M42 nickel satin finish  
 centre-to-centre distance varies according to the door

for handles from W 78 to W 484 for handle  
 W 784  
 size see technical diagram

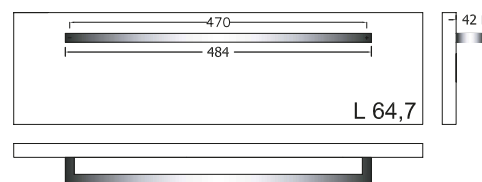
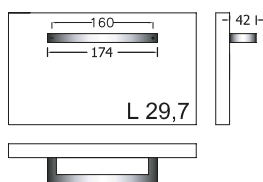
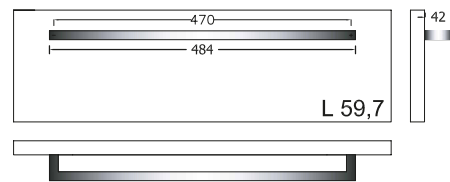
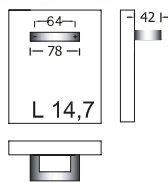
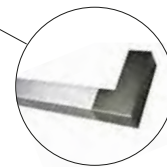

**ANGOLO PENSILE A LIBRO**  
 corner wall unit folding

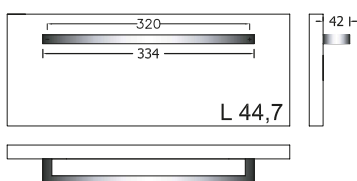
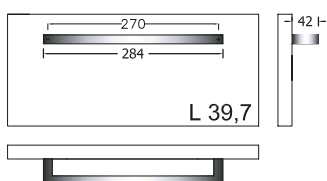
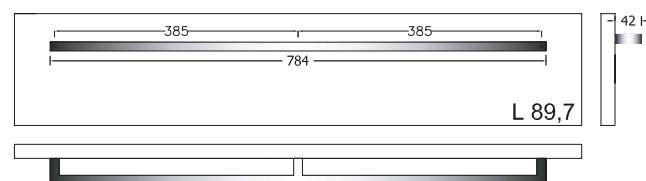
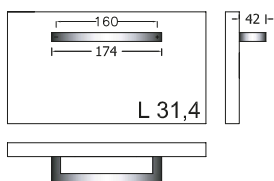



## MANIGLIA VERTICALE HANDLE VERTICAL



Maniglia M40V finitura nero soft  
passo in funzione dell'anta  
Handle M40V soft black finish  
centre-to-centre distance varies according to the door



Maniglia M42V finitura nichel satinata  
passo in funzione dell'anta  
Handle M42V nickel satin finish  
centre-to-centre distance varies according to the door

per maniglia L 334  
per maniglia L 934  
per maniglia L 1347  
vedi schema tecnico

for handle W 334  
for handle W 934  
for handle W 1347  
size see technical diagram

**N.B.:** la maniglia verticale non è disponibile per tutti gli elementi. Non inseribile su pensili, basi con cassetti e cestone  
**Note:** The vertical handle is not compatible with all the elements. Is not possible to insert it on the wall units and base units with drawers and deep drawers.

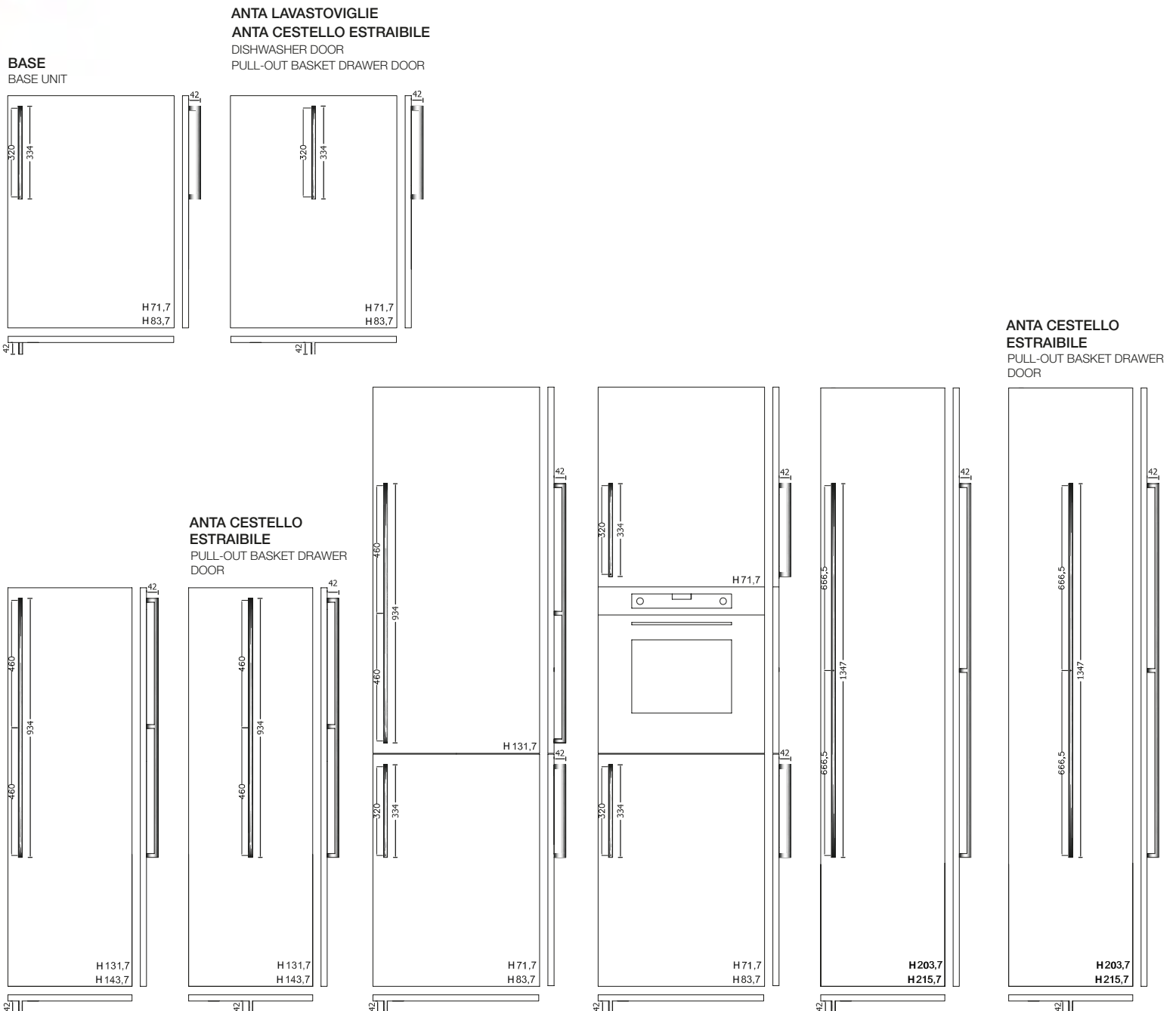

## MANIGLIE HANDLES

---

### DI SERIE STANDARD



Maniglia H01 finitura alluminio satinato  
Handle H01 satin aluminium finish

### A RICHIESTA ON REQUEST



Maniglia H20 finitura cromo  
N.B.: In presenza di questa maniglia  
non si possono tassativamente realizzare fuori misura in larghezza.

Handle H20 chrome finish  
Note: Custom-sized length elements cannot be realized using this handle.

per maniglia L 15 a L 65  
per maniglia L 90

for handle W 15 to W 65  
for handle W 90



## MANIGLIE HANDLES

---

N.B.: In presenza di questa maniglia non si possono tassativamente realizzare fuori misura in larghezza.  
Note: Custom-sized length elements cannot be realized using this handle.



Maniglia H51 finitura urban  
per maniglie da L 15 a L 65  
per maniglia da L 90  
vedi schema tecnico

Handle H51 urban finish  
for handles from W 15 to W 65  
for handle from W 90  
size see technical diagram



Maniglia H52 finitura titanio  
per maniglie da L 15 a L 65  
per maniglia da L 90  
vedi schema tecnico

Handle H52 titanium finish  
for handles from W 15 to W 65  
for handle from W 90  
size see technical diagram



Maniglia H53 finitura silver dark  
per maniglie da L 15 a L 65  
per maniglia da L 90  
vedi schema tecnico

Handle H53 dark silver finish  
for handles from W 15 to W 65  
for handle from W 90  
size see technical diagram

## SCHEMA MANIGLIE HANDLES DIAGRAM

### MANIGLIA APPLICATA IN TESTA TOP-MOUNTED HANDLE

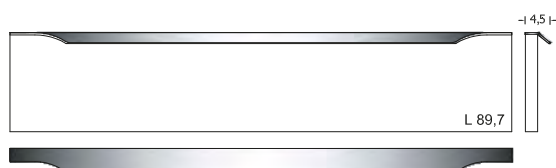
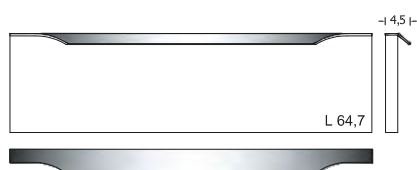
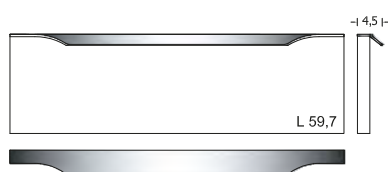
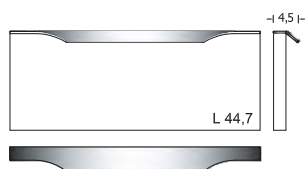
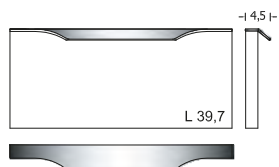
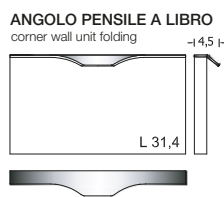
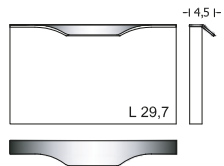
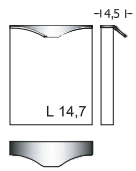

### MANIGLIA FRONTALE PER ANTA COLONNA FRONT DOOR HANDLE FOR COLUMN

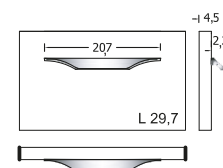
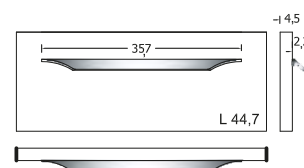
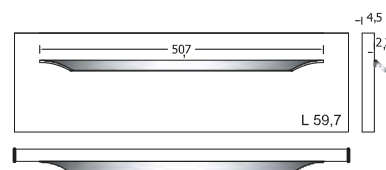
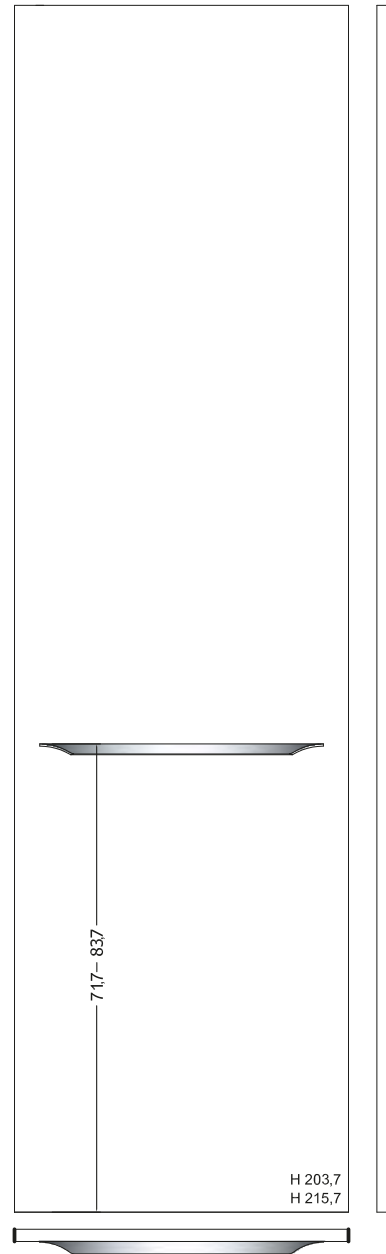



## MANIGLIE HANDLES

---

N.B.: In presenza di questa maniglia non si possono tassativamente realizzare fuori misura in larghezza.  
Note: Custom-sized length elements cannot be realized using this handle.



Maniglia H61 finitura verniciato ghisa  
per maniglie da L 15 a L 65  
per maniglia da L 90  
vedi schema tecnico

Handle H61 cast iron painted finish  
for handles from W 15 to W 65  
for handle from W 90  
size see technical diagram



Maniglia H62 finitura titanio  
per maniglie da L 15 a L 65  
per maniglia da L 90  
vedi schema tecnico

Handle H62 titanium finish  
for handles from W 15 to W 65  
for handle from W 90  
size see technical diagram



Maniglia H63 finitura silver dark  
per maniglie da L 15 a L 65  
per maniglia da L 90  
vedi schema tecnico

Handle H63 dark silver finish  
for handles from W 15 to W 65  
for handle from W 90  
size see technical diagram

## SCHEMA MANIGLIE HANDLES DIAGRAM

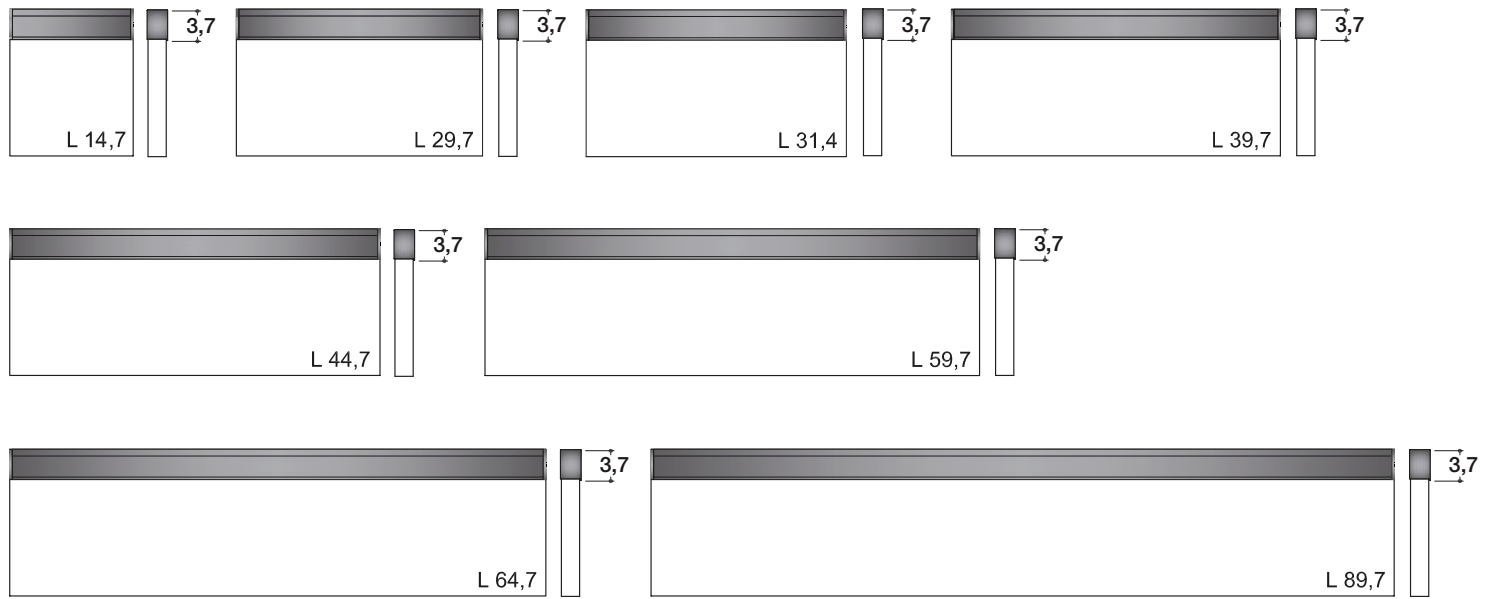

Anta monoporta con maniglia in verticale  
Single-door with handle vertical

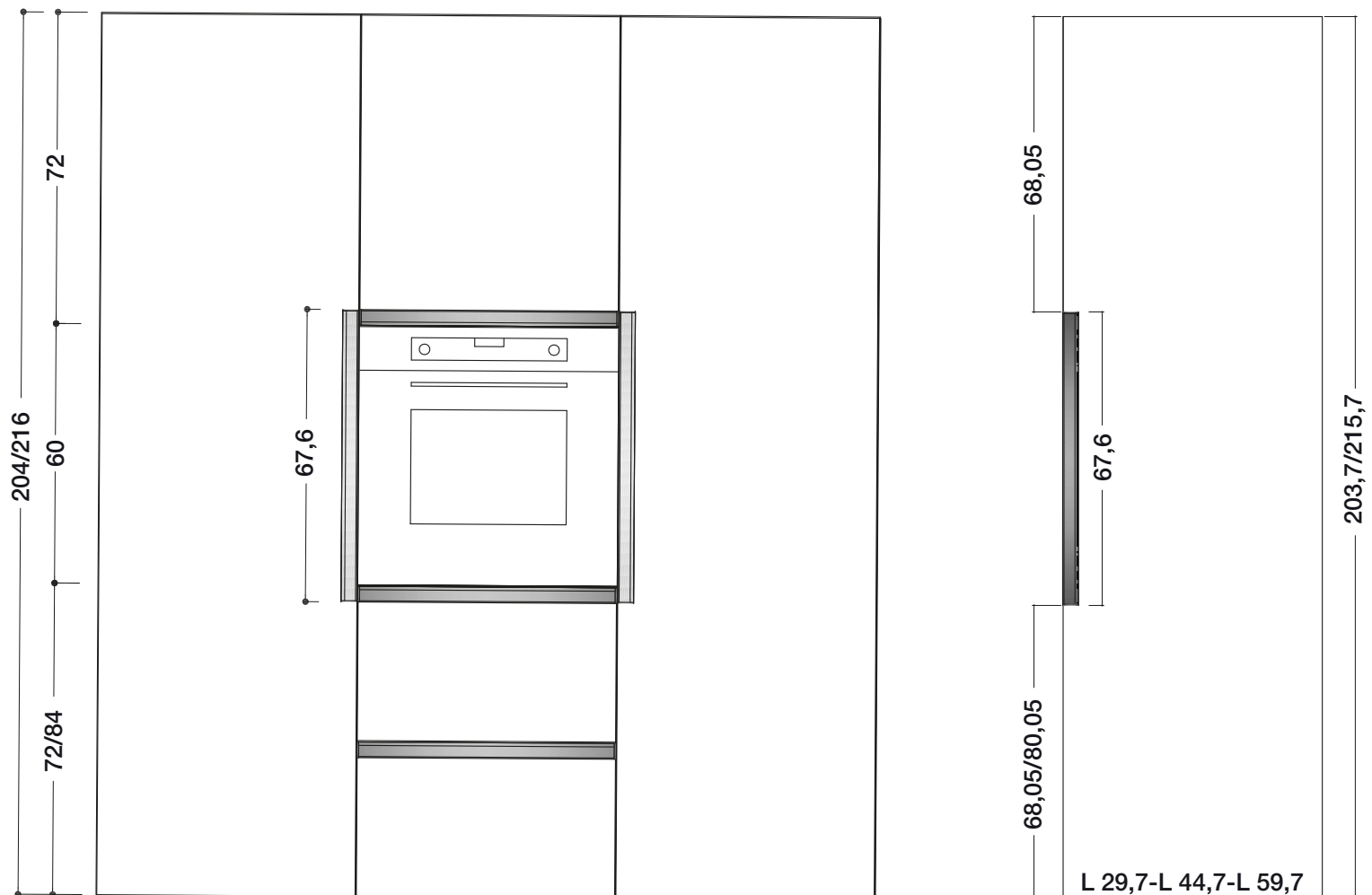

## strutture carcasses



bianco (opz.001)  
schiena e ripiano bianco  
(opz.001)  
white (opt.001)  
white back panel and shelf  
(opt.001)



visone (opz.948M)  
schiena e ripiano visone  
(opz.948M)  
mink (opt.948M)  
mink back panel and shelf  
(opt.948M)



fango (opz.8860)  
schiena e ripiano fango  
(opz.8860)  
mud (opt.8860)  
mud back panel and shelf  
(opt.8860)



lavagna (opz.9620)  
schiena e ripiano lavagna  
(opz.9620)  
slate grey (opt.9620)  
slate grey back panel  
and shelf (opt.9620)



conchiglia (opz.8910)  
schiena e ripiano conchiglia  
(opz.8910)  
shell (opt.8910)  
shell back panel and shelf  
(opt.8910)



argilla (opz.9690)  
schiena e ripiano argilla  
(opz.9690)  
clay (opt.9690)  
clay back panel and shelf  
(opt.9690)

**N.B.: prodotti conformi al regolamento US EPA TSCA Title VI riguardo emissione formaldeide**  
Note: products are compliant with US EPA TSCA TITLE VI regulations governing formaldehyde emissions



### LUBE ECOLOGIC

IL GRUPPO LUBE HA SCELTO DI UTILIZZARE PER I COMPONENTI COSTITUENTI LE STRUTTURE DELLE CUCINE SOLO MATERIALE A BASSISSIMA EMISSIONE DI FORMALDEIDE: CONFORMI ALLO STANDARD F\*\*\*\* SECONDO LA NORMA JIS, CERTIFICATO DAL MINISTERO GIAPPONESE, IL PIU' SEVERO IN MERITO ALLE NORMATIVE DI SALVAGUARDIA AMBIENTALE.

LUBE GROUP HAS CHOSEN TO EXCLUSIVELY USE MATERIALS WITH VERY LOW FORMALDEHYDE EMISSIONS FOR THE COMPONENTS MAKING UP THE KITCHEN CARCASSES: THESE ELEMENTS COMPLY WITH THE F4 STAR STANDARD ACCORDING TO JIS, CERTIFIED BY THE JAPANESE GOVERNMENT - THE MOST STRINGENT WHEN IT COMES TO ENVIRONMENTAL PROTECTION.

## mensole in laminato P 31-61 come strutture same colours as carcasses laminate shelves D 31-61



bianco (opz.001)  
white (opt.001)



visone (opz.948M)  
mink (opt.948M)



fango (opz.8860)  
mud (opt.8860)



lavagna (opz.9620)  
slate grey (opt.9620)



conchiglia (opz.8910)  
shell (opt.8910)

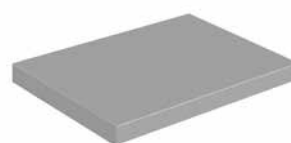

argilla (opz.9690)  
clay (opt.9690)

## mensole P 31-61 impialacciate veneered shelves D 31-61



colori come ante  
colours same as door

## zoccoli in pvc H 13 pvc plinths H 13

di serie  
standard



acciaio (opz.407)  
steel (opt.407)

alluminio satinato  
(opz.405)  
satin aluminium  
(opt.405)

bianco (opz.001)  
white (opt.001)

## zoccoli in alluminio H 13 aluminium plinths H 13



alluminio  
finitura brill (opz.412)  
aluminium  
brill finish (opt.412)

alluminio finitura titanio  
ossidato (opz.414)  
aluminium titanium  
oxidized finish (opt.414)

urban ossidato  
(opz.NU)  
urban oxidized finish  
(opt.NU)

## zoccoli in alluminio H 13 verniciati a polvere finitura opaca aluminium plinths H 13 powder coated matt finish



alluminio finitura nero  
(opz.7892)  
aluminium  
black finish (opt.7892)

alluminio finitura fumo  
(opz.9531)  
aluminium  
smoke finish (opt.9531)

alluminio finitura  
bianco caldo (opz.7401)  
aluminium warm white  
finish (opt.7401)

alluminio finitura  
bianco assoluto (opz.740S)  
aluminium absolute  
white finish (opt.740S)



alluminio finitura  
acquamarina  
(opz.8323)  
aluminium aquamarine  
finish (opt.8323)

alluminio finitura giallo  
ambra (opz.8225)  
aluminium amber  
yellow finish (opt.8225)

alluminio finitura salvia  
(opz.8443)  
aluminium sage  
finish (opt.8443)

alluminio finitura rosso  
corallo (opz.8131)  
aluminium coral red  
finish (opt.8131)

alluminio finitura rosa  
quarzo (opz.8171)  
aluminium quartz  
pink finish (opt.8171)



alluminio finitura rosso  
toscano (opz.8157)  
aluminium tuscan red  
finish (opt.8157)

alluminio finitura  
grigio bromo (opz.9533)  
aluminium bromine grey  
finish (opt.9533)

alluminio finitura  
castoro (opz.8907)  
aluminium beaver  
finish (opt.8907)

alluminio finitura  
argilla (opz.9503)  
aluminium clay  
finish (opt.9503)

alluminio finitura  
cenere (opz.9547)  
aluminium ash  
finish (opt.9547)



alluminio grigio  
traffico (opz.9511)  
aluminium traffic grey  
finish (opt.9511)

alluminio finitura  
conchiglia (opz.7403)  
aluminium shell  
finish (opt.7403)

alluminio finitura  
ghisa (opz.9509)  
aluminium cast iron  
finish (opt.9509)

alluminio finitura  
giallo mais (opz.8251)  
aluminium corn yellow  
finish (opt.8251)

alluminio finitura  
grigio piombo  
(opz.9537)  
aluminium lead grey  
finish (opt.9537)

alluminio finitura  
silver dark (opz.9507)  
aluminium dark silver  
finish (opt.9507)

# MODULARITÀ E COMPONIBILITÀ MODULARITY AND FITTING SOLUTIONS

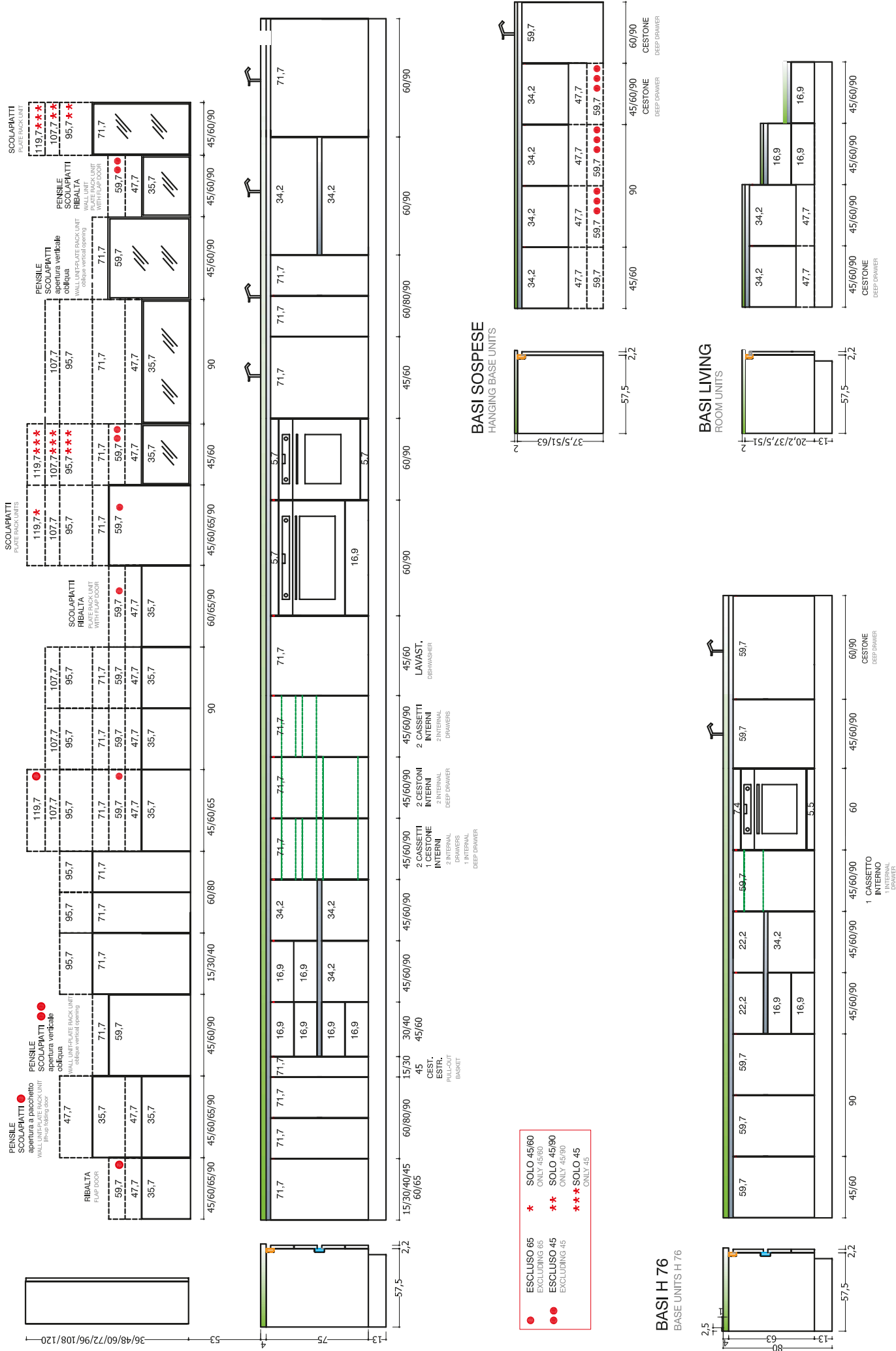





# MODULARITÀ E COMPONENTIBILITÀ MODULARITY AND FITTING SOLUTIONS

COLONNE FRIGO  
FRIDGE COLUMNS

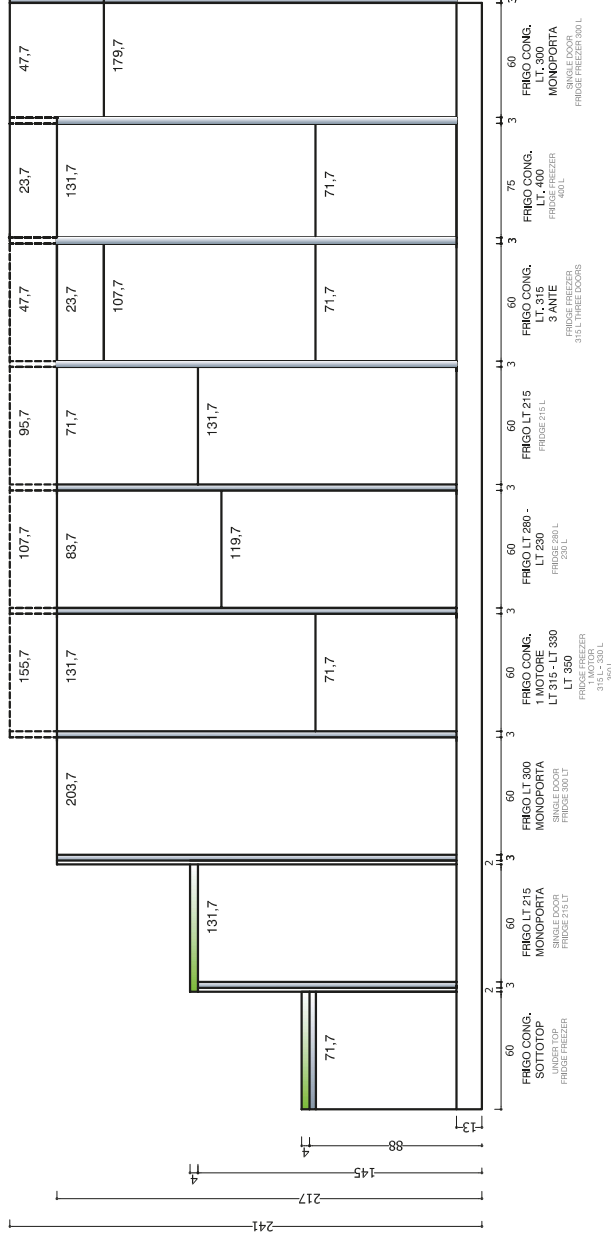
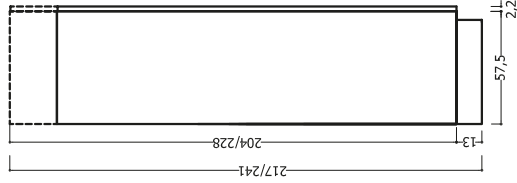

COLONNE FORNO  
OVEN COLUMNS

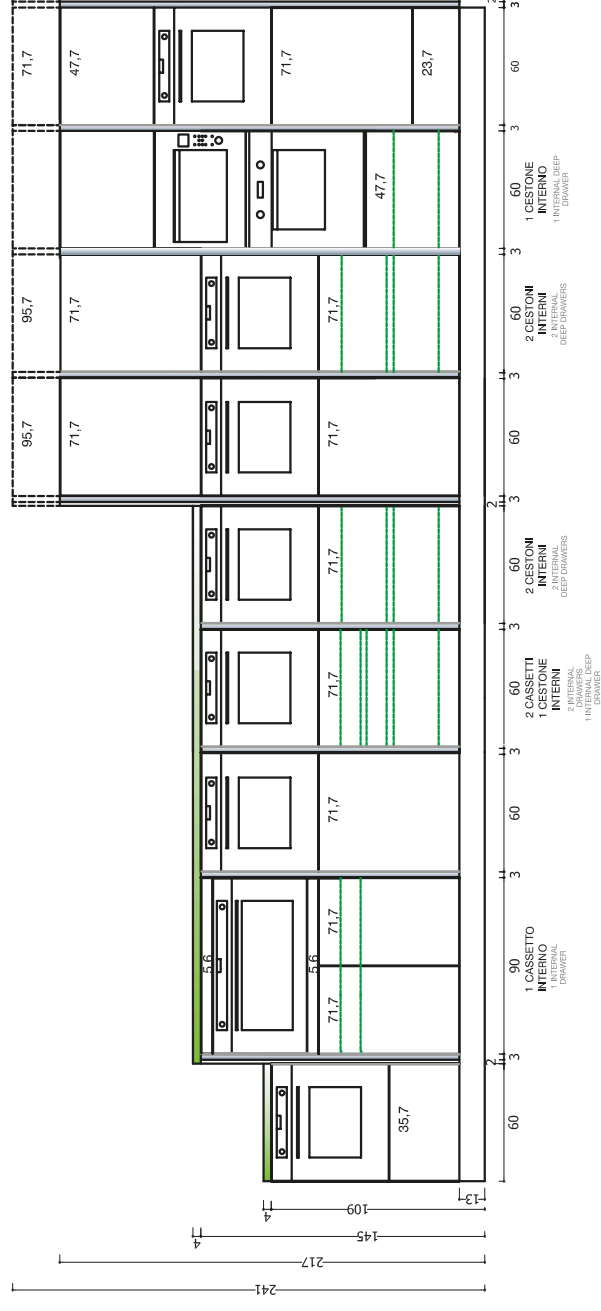
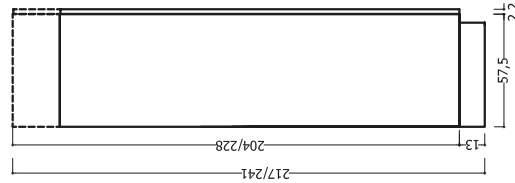

## MODULARITÀ E COMPONENTIBILITÀ MODULARITY AND FITTING SOLUTIONS

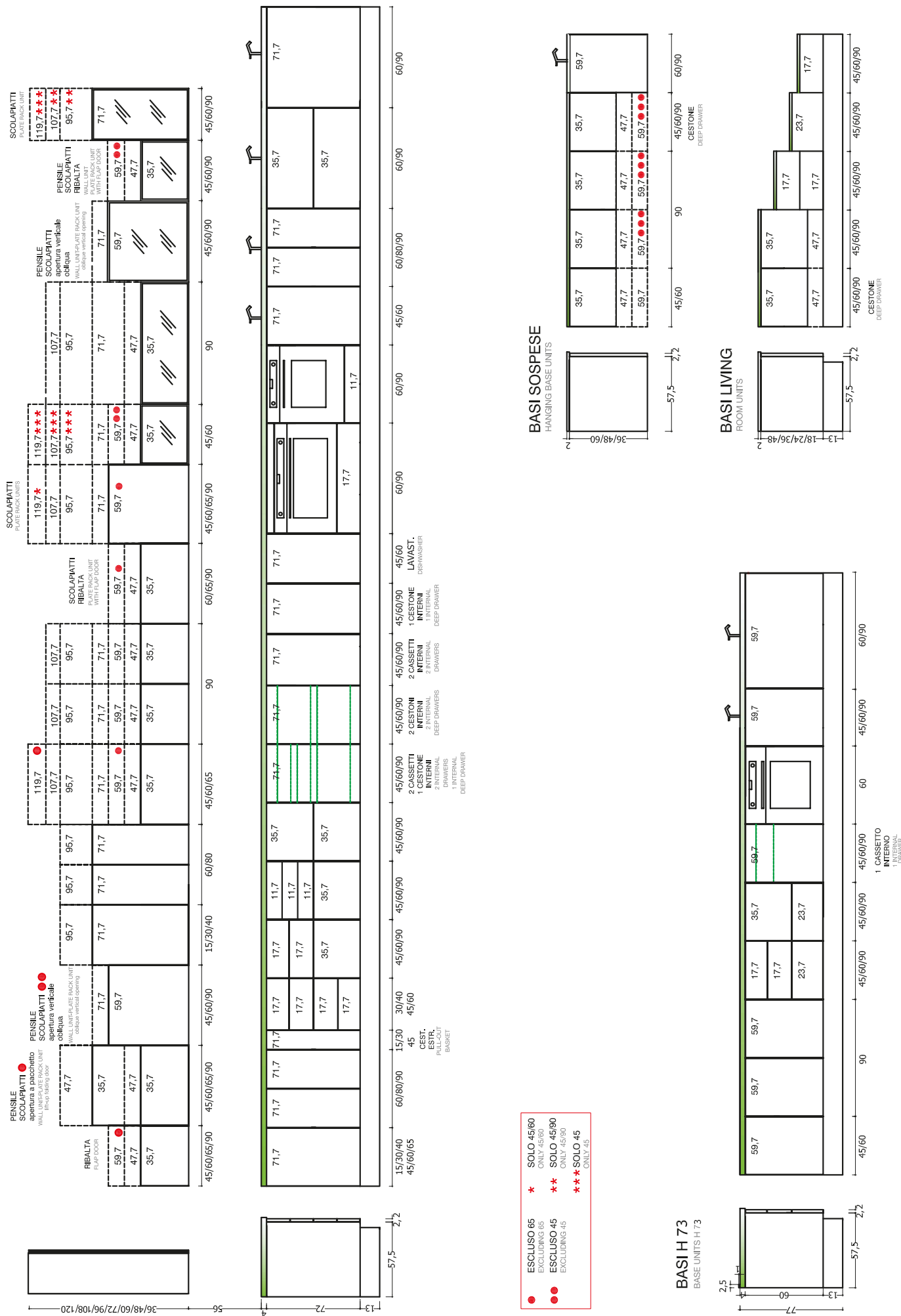

## MODULARITÀ E COMPONENTI MODULARITÀ AND FITTING SOLUTIONS

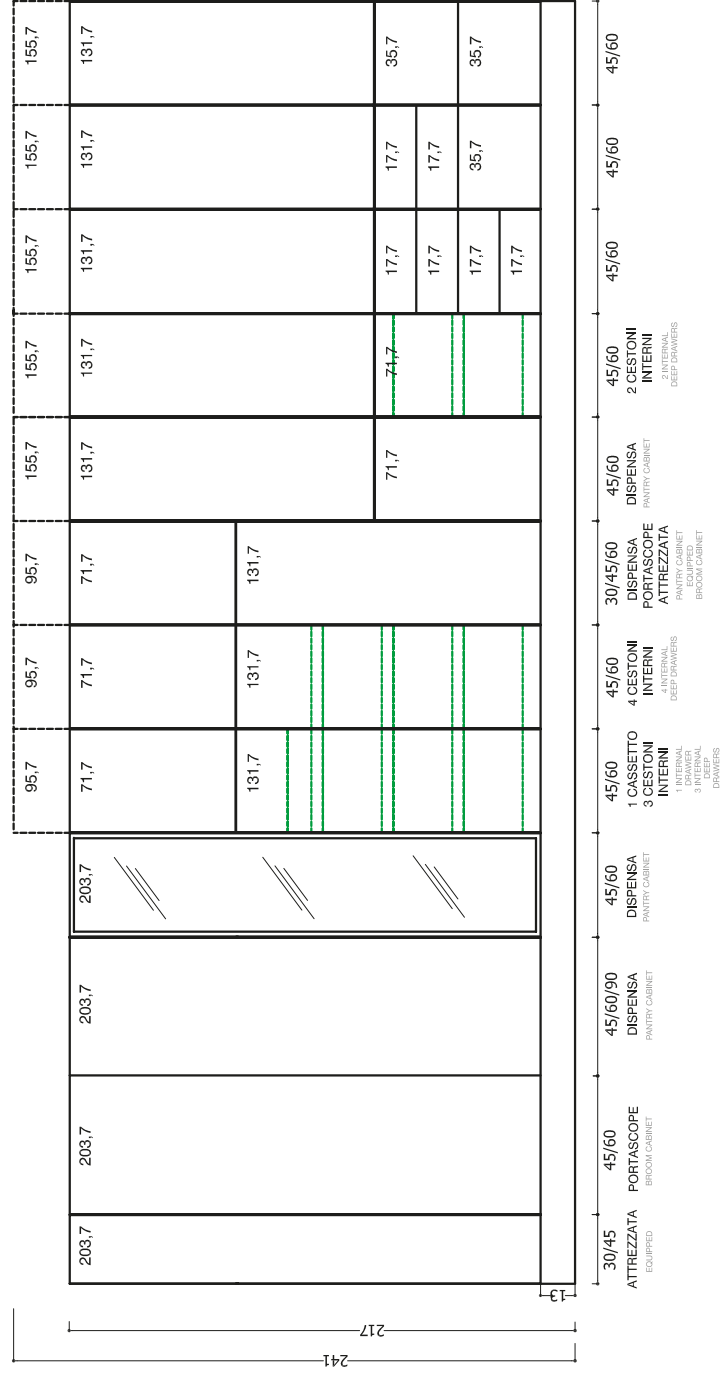
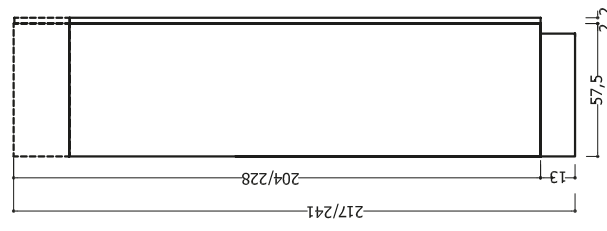
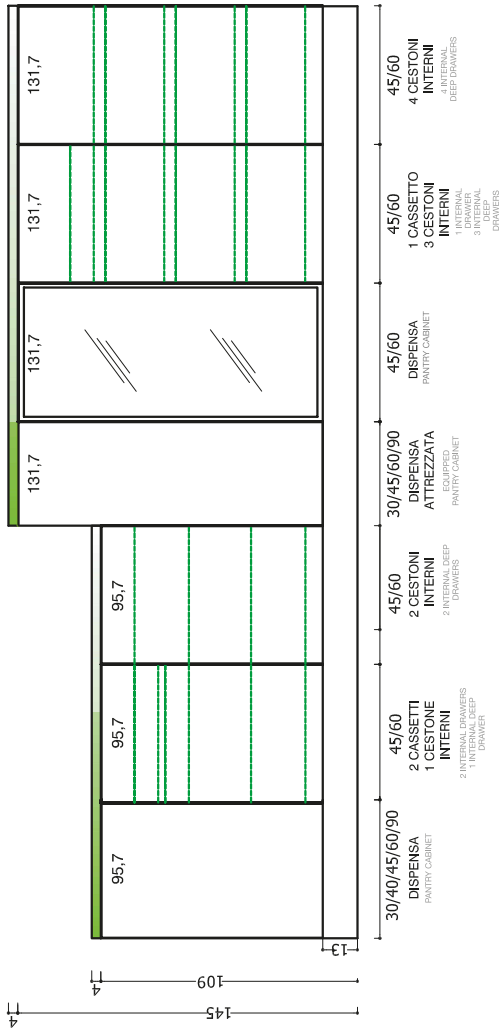
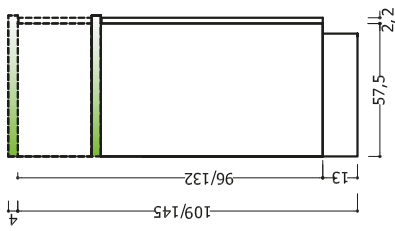



**APERTURA A RIBALTA**

Le ante aprendosi verso l'alto consentono di avere un' ampia visione d'insieme all'interno del mobile.

La regolazione della forza di apertura può essere impostata in modo esatto in base al peso del frontale. Grazie all'arresto progressivo le ante si fermano in qualsiasi posizione; in questo modo la maniglia è sempre facilmente raggiungibile. La chiusura è ammortizzata e un'unica manovra è sufficiente per regolare il frontale tridimensionalmente grazie all'assenza di cerniere e al sistema di aggancio clip.

WALL UNIT WITH FLAP DOOR

The doors that open upwards guarantee ample overall visibility inside the cabinet.

The opening force can be adjusted precisely according to the weight of the front. The doors stop in any position thanks to the gradual stopping movement; in this way, the handle is always easily accessible. The closing movement is cushioned and a single manoeuvre is required to three-dimensionally adjust the front, thanks to the clip-on system and the absence of hinges.



**DI SERIE STANDARD**



**MOTORIZZATO SERVO-DRIVE**  
SERVO-DRIVE  
MOTORISED  
(Opz.007)



	A	B	C
H 36	11,5	3,5	37
H 48	15	3,5	49
H 60	18,5	3,5	61

Per evitare l'interferenza dell'anta in fase di apertura con cornici o mensole, si può richiedere il limitatore dell'angolo di apertura cod. 5620010

In order to avoid that the door interferes with cornices or shelves during the opening movement, it is possible to request an opening angle limiter: code 5620010

e

**SCHEMA MONTAGGIO LIMITATORE PER RIBALTA H 36**  
FLAP DOOR LIMITER INSTALLATION  
DIAGRAM H 36

**SCHEMA MONTAGGIO LIMITATORE PER RIBALTA H 48**  
FLAP DOOR LIMITER INSTALLATION  
DIAGRAM H 48

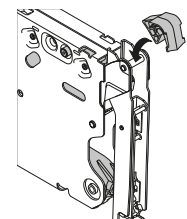
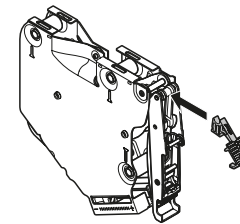

**APERTURA VERTICALE OBLIQUA**

I pensili con questo tipo di meccanismo necessitano per l'apertura di poco spazio libero sopra il mobile grazie al movimento basculante dell'anta che si apre senza difficoltà applicando poca forza anche in presenza di frontali pesanti. Con l'arresto progressivo le ante si fermano in qualsiasi posizione; in questo modo la maniglia è sempre facilmente raggiungibile. La chiusura è ammortizzata ed è possibile regolare la forza di tenuta in base al peso del frontale.

VERTICAL OPENING OBLIQUE

Wall units that mount this type of mechanism require little clearance above the cabinet thanks to the swivelling movement of the door that can be easily opened by applying slight pressure, even with heavy fronts. The doors stop in any position thanks to the gradual stopping movement; in this way, the handle is always easily accessible. The closing movement is cushioned and the closing force can be adjusted according to the weight of the front door.



**DI SERIE STANDARD**



**MOTORIZZATO SERVO-DRIVE**  
SERVO-DRIVE  
MOTORISED  
(Opz.007)

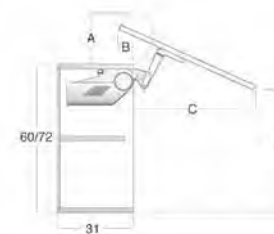

	A	B	C	D
H 60	18	9,6	46,5	53,5
H 72	18	9,6	57	61



**APERTURA VERTICALE**

L'anta ad apertura verticale, potendo essere sollevata completamente verso l'alto, consente un accesso totale all'interno del pensile. Ideale per l'impiego in mobili a colonna per nascondere ad esempio apparecchi elettrici, o pensili con corpi mobili sovrastanti, ha la chiusura ammortizzata e la possibilità di regolare la forza di tenuta in base al peso del frontale.

VERTICAL OPENING

Doors with vertical opening movement can be fully raised to fully access the inside of the wall unit.

Ideal for use on column units to conceal electrical appliances for examples, or on wall units surmounted by mobile units.

The closing movement is cushioned and the closing force can be adjusted according to the weight of the front door.



**DI SERIE  
STANDARD**



**MOTORIZZATO  
SERVO-DRIVE  
SERVO-DRIVE  
MOTORISED  
(Opz.007)**

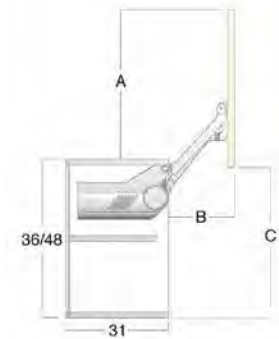

	A	B	C
H 36	34	23,5	34,5
H 48	43	28,5	43,5

**APERTURA ANTE A PACCHETTO**

Il meccanismo d'apertura ante a pacchetto è idoneo sul pensile H 72; la regolazione della forza di apertura può essere impostata in modo esatto in base ai pesi dei frontali, la chiusura è ammortizzata e la cerniera centrale clip si contraddistingue per l'innovativa tecnologia che garantisce la sicurezza per le dita.

LIFT-UP FOLDING DOORS

The lift-up folding door opening mechanism is suitable for wall units with H 72; the opening force can be adjusted precisely according to the weight of the fronts, while the closing movement is cushioned and the central clip-on hinge features innovative technology for safeguarding the fingers.



**DI SERIE  
STANDARD**



**MOTORIZZATO  
SERVO-DRIVE  
SERVO-DRIVE  
MOTORISED  
(Opz.007)**

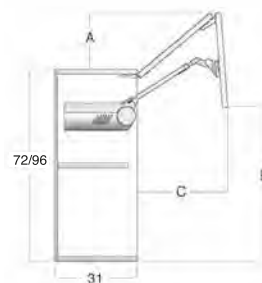

	A	B	C
H 72	16,5	54	41
H 96	20	69	53

**SCHEMA MONTAGGIO  
LIMITATORE  
LIMITER INSTALLATION  
DIAGRAM**

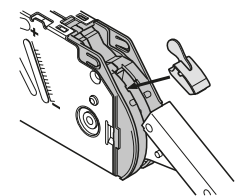

**Per evitare l'interferenza dell'anta in fase di apertura con cornici o mensole, si può richiedere il limitatore dell'angolo di apertura cod. 5620005**

In order to avoid that the door interferes with cornices or shelves during the opening movement, it is possible to request an opening angle limiter: code 5620005

## COLONNE ARMADIO “NOOK” H 217 P 70,4 CON ANTE A SCOMPARSA

“NOOK” CLOSET COLUMNS H 217 D 70,4 WITH DOORS INWARDS

Le colonne armadio “Nook” con ante a scomparsa, consentono di inserire all’interno forno, frigo, tavolo e cassetti

“Nook” closet columns with pull-out doors allow to insert oven, fridge, table and drawer on the inside





## COLONNE ARMADIO “NOOK” H 217 P 70,4 CON ANTE A SCOMPARSA

“NOOK” CLOSET COLUMNS H 217 D 70,4 WITH DOORS INWARDS

Il tavolo estraibile è disponibile nella versione inox o in laminato, nella finitura oak cognac

The pull-out table it's available in stainless steel version or laminate oak cognac finish



# Immagina **wood** LUX Neck

**ZOCCOLO**  
H 6 centimetri  
=  
più volume di  
contenimento

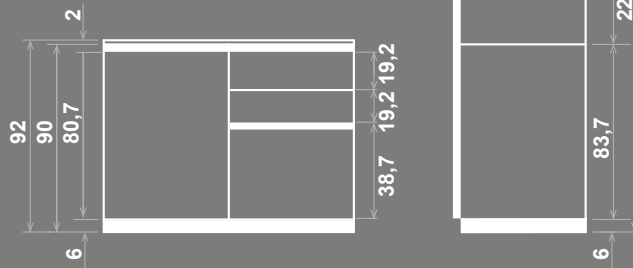

Con lo **zoccolo** ad altezza ridotta a 6 cm, si possono **guadagnare centimetri preziosi di contenimento**, dando alla cucina l'aspetto elegante di un living.

*Valuable space has been saved by lowering the plinth to 6 cm, and so the kitchen will take on a stylish look such as a living room.*



## strutture carcasses



bianco (opz.001)  
schiena e ripiano bianco  
(opz.001)  
white  
white back panel and shelf

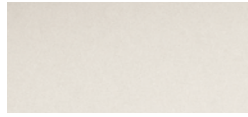

conchiglia (opz.8910)  
schiena e ripiano conchiglia  
(opz.8910)  
shell  
shell back panel and shelf



lavagna (opz.9620)  
schiena e ripiano lavagna  
(opz.9620)  
slate grey  
slate grey back panel and shelf



fango (opz.8860)  
schiena e ripiano fango  
(opz.8860)  
mud  
mud back panel and shelf



visone (opz.948M)  
schiena e ripiano visone  
(opz.948M)  
mink  
mink back panel and shelf



argilla (opz.9690)  
schiena e ripiano argilla  
(opz.9690)  
clay  
clay back panel and shelf

## zoccoli in alluminio H 6 aluminium plinths H 6



alluminio  
finitura brill (opz.412)  
aluminium  
brill finish (opt.412)



alluminio finitura titanio  
ossidato (opz.414)  
aluminium titanium  
oxidized finish (opt.414)



urban ossidato  
(opz.NU)  
urban oxidized finish  
(opt.NU)

## zoccoli in alluminio H 6 verniciati a polvere finitura opaca aluminum plinths H 6 powder coated matt finish



alluminio finitura nero  
(opz.7892)  
aluminium  
black finish (opt.7892)



alluminio finitura fumo  
(opz.9531)  
aluminium  
smoke finish (opt.9531)



alluminio finitura  
bianco caldo (opz.7401)  
aluminium warm  
white finish (opt.7401)



alluminio finitura  
bianco assoluto (opz.740S)  
aluminium absolute  
white finish (opt.740S)



alluminio finitura  
acquamarina  
(opz.8323)  
aluminium aquamarine  
finish (opt.8323)



alluminio finitura giallo  
ambra (opz.8225)  
aluminium amber  
yellow finish (opt.8225)



alluminio finitura salvia  
(opz.8443)  
aluminium sage  
finish (opt.8443)



alluminio finitura rosso  
corallo (opz.8131)  
aluminium coral red  
finish (opt.8131)



alluminio finitura rosa  
quarzo (opz.8171)  
aluminium quartz  
pink finish (opt.8171)



alluminio finitura rosso  
toscano (opz.8157)  
aluminium tuscan red  
finish (opt.8157)



alluminio finitura  
grigio bromo (opz.9533)  
aluminium bromine  
grey finish (opt.9533)



alluminio finitura  
castoro (opz.8907)  
aluminium beaver  
finish (opt.8907)



alluminio finitura  
argilla (opz.9503)  
aluminium clay  
finish (opt.9503)



alluminio finitura  
cenere (opz.9547)  
aluminium ash  
finish (opt.9547)



alluminio grigio traffico  
(opz.9511)  
aluminium traffic grey  
finish (opt.9511)



alluminio finitura  
conchiglia (opz.7403)  
aluminium shell  
finish (opt.7403)



alluminio finitura  
ghisa (opz.9509)  
aluminium cast iron  
finish (opt.9509)



alluminio finitura  
giallo mais (opz.8251)  
aluminium corn yellow  
finish (opt.8251)



alluminio finitura  
grigio piombo  
(opz.9537)  
aluminium lead grey  
finish (opt.9537)



alluminio finitura  
silver dark (opz.9507)  
aluminium dark silver  
finish (opt.9507)





MODULARITÀ E COMPONENTITÀ MODULARITY AND FITTING SOLUTIONS

Immagina **Wood** Lux  
**Neck**

COLONNE FRIGO  
FRIDGE COLUMNS

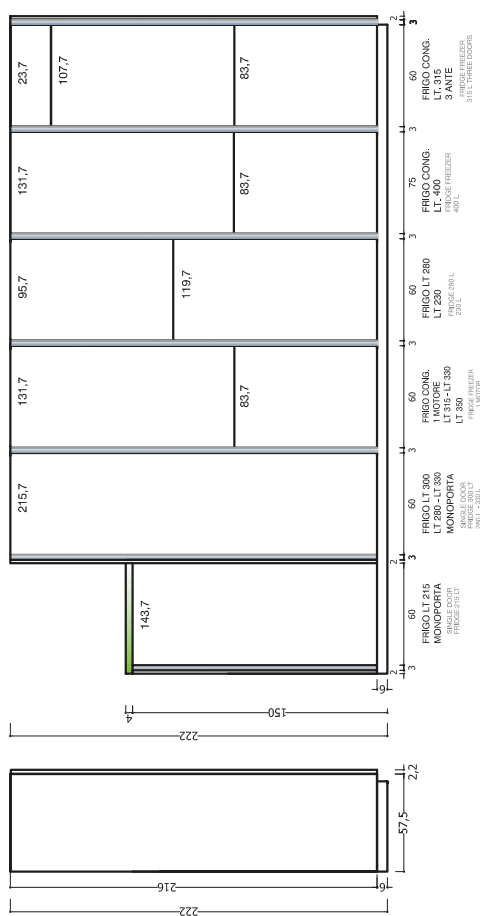

COLONNE COLUMNS

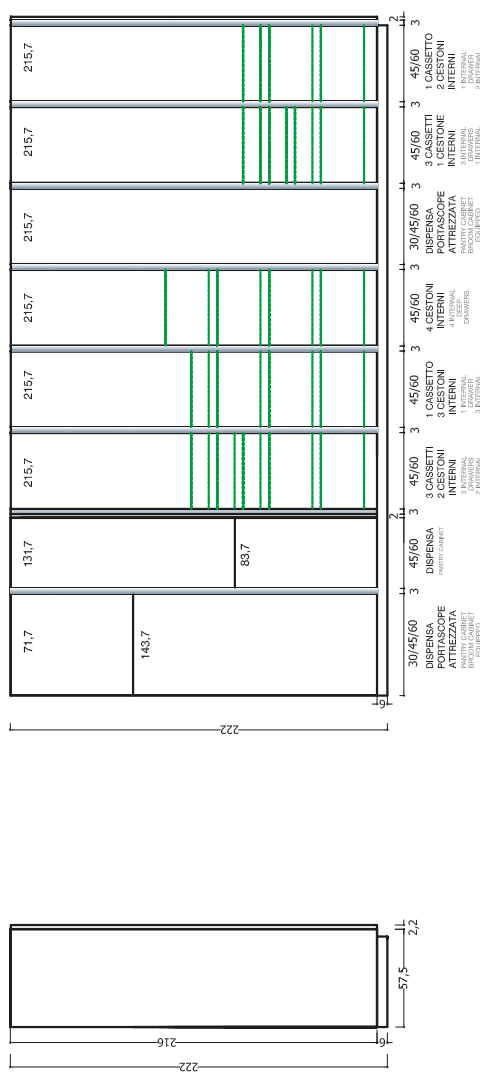

COLONNE FORNO  
OVEN COLUMNS

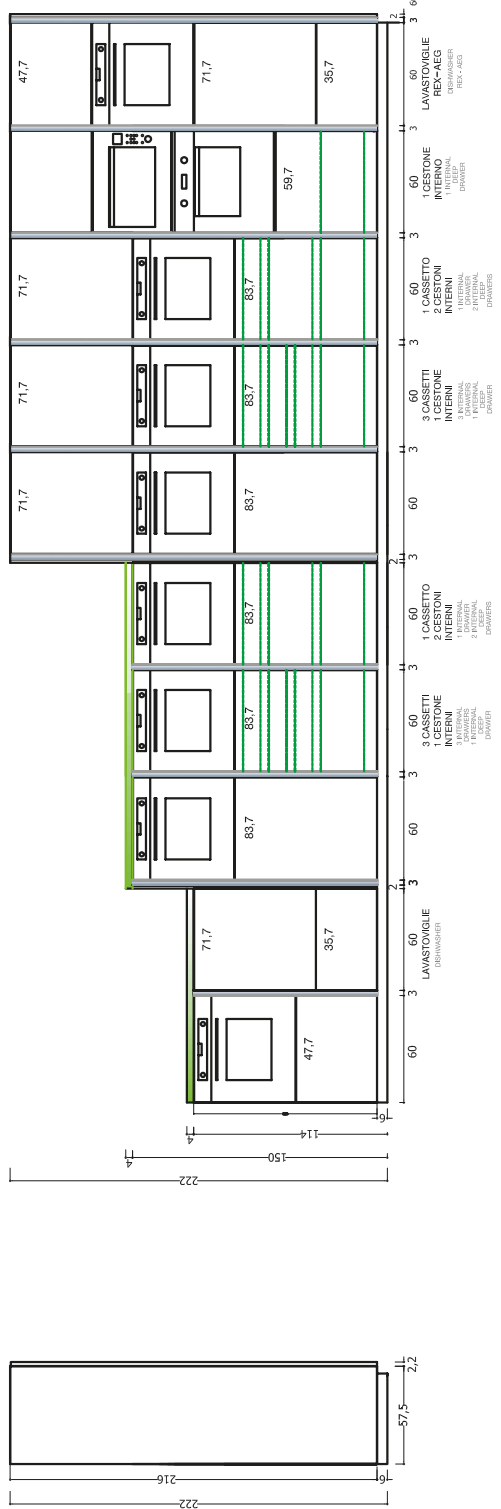

# Immagina **wood** Bridge Head

**ZOCCOLO**  
H 6 centimetri  
=  
più volume di  
contenimento

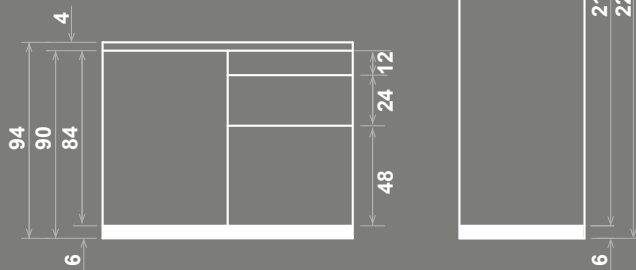

Con lo zoccolo ad altezza ridotta a 6 cm, si possono guadagnare centimetri preziosi di contenimento, dando alla cucina l'aspetto elegante di un living.

*Valuable space has been saved by lowering the plinth to 6 cm, and so the kitchen will take on a stylish look such as a living room.*



# Immagina **Wood** Bridge Head

## strutture carcasses



bianco (opz.001)  
schiena e ripiano bianco  
(opz.001)  
white  
white back panel and shelf

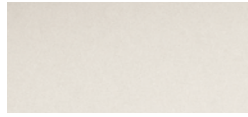

conchiglia (opz.8910)  
schiena e ripiano conchiglia  
(opz.8910)  
shell  
shell back panel and shelf



lavagna (opz.9620)  
schiena e ripiano lavagna  
(opz.9620)  
slate grey  
slate grey back panel and shelf



fango (opz.8860)  
schiena e ripiano fango  
(opz.8860)  
mud  
mud back panel and shelf



visone (opz.948M)  
schiena e ripiano visone  
(opz.948M)  
mink  
mink back panel and shelf



argilla (opz.9690)  
schiena e ripiano argilla  
(opz.9690)  
clay  
clay back panel and shelf

## zoccoli in alluminio H 6 aluminium plinths H 6



alluminio  
finitura brill (opz.412)  
aluminium  
brill finish (opt.412)



alluminio finitura titanio  
ossidato (opz.414)  
aluminium titanium  
oxidized finish (opt.414)



urban ossidato  
(opz.NU)  
urban oxidized finish  
(opt.NU)

## zoccoli in alluminio H 6 verniciati a polvere finitura opaca aluminum plinths H 6 powder coated matt finish



alluminio finitura nero  
(opz.7892)  
aluminium  
black finish (opt.7892)



alluminio finitura fumo  
(opz.9531)  
aluminium  
smoke finish (opt.9531)



alluminio finitura  
bianco caldo (opz.7401)  
aluminium warm  
white finish (opt.7401)



alluminio finitura  
bianco assoluto (opz.740S)  
aluminium absolute  
white finish (opt.740S)



alluminio finitura  
acquamarina  
(opz.8323)  
aluminium aquamarine  
finish (opt.8323)



alluminio finitura giallo  
ambra (opz.8225)  
aluminium amber  
yellow finish (opt.8225)



alluminio finitura salvia  
(opz.8443)  
aluminium sage  
finish (opt.8443)



alluminio finitura rosso  
corallo (opz.8131)  
aluminium coral red  
finish (opt.8131)



alluminio finitura rosa  
quarzo (opz.8171)  
aluminium quartz  
pink finish (opt.8171)



alluminio finitura rosso  
toscano (opz.8157)  
aluminium tuscan red  
finish (opt.8157)



alluminio finitura  
grigio bromo (opz.9533)  
aluminium bromine  
grey finish (opt.9533)



alluminio finitura  
castoro (opz.8907)  
aluminium beaver  
finish (opt.8907)



alluminio finitura  
argilla (opz.9503)  
aluminium clay  
finish (opt.9503)



alluminio finitura  
cenere (opz.9547)  
aluminium ash  
finish (opt.9547)



alluminio grigio traffico  
(opz.9511)  
aluminium traffic grey  
finish (opt.9511)



alluminio finitura  
conchiglia (opz.7403)  
aluminium shell  
finish (opt.7403)



alluminio finitura  
ghisa (opz.9509)  
aluminium cast iron  
finish (opt.9509)



alluminio finitura  
giallo mais (opz.8251)  
aluminium corn yellow  
finish (opt.8251)



alluminio finitura  
grigio piombo  
(opz.9537)  
aluminium lead grey  
finish (opt.9537)



alluminio finitura  
silver dark (opz.9507)  
aluminium dark silver  
finish (opt.9507)



## MODULARITÀ E COMPONIBILITÀ MODULARITY AND FITTING SOLUTIONS

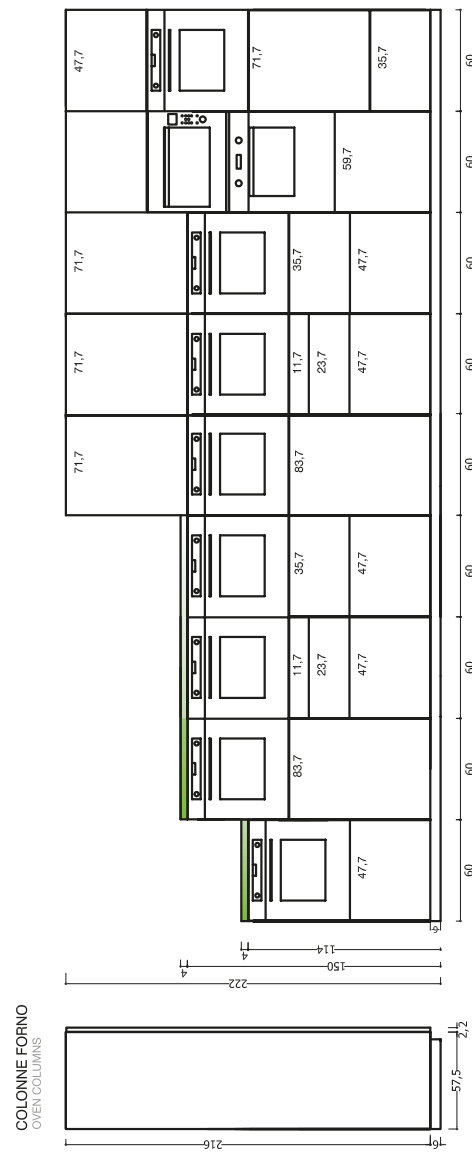
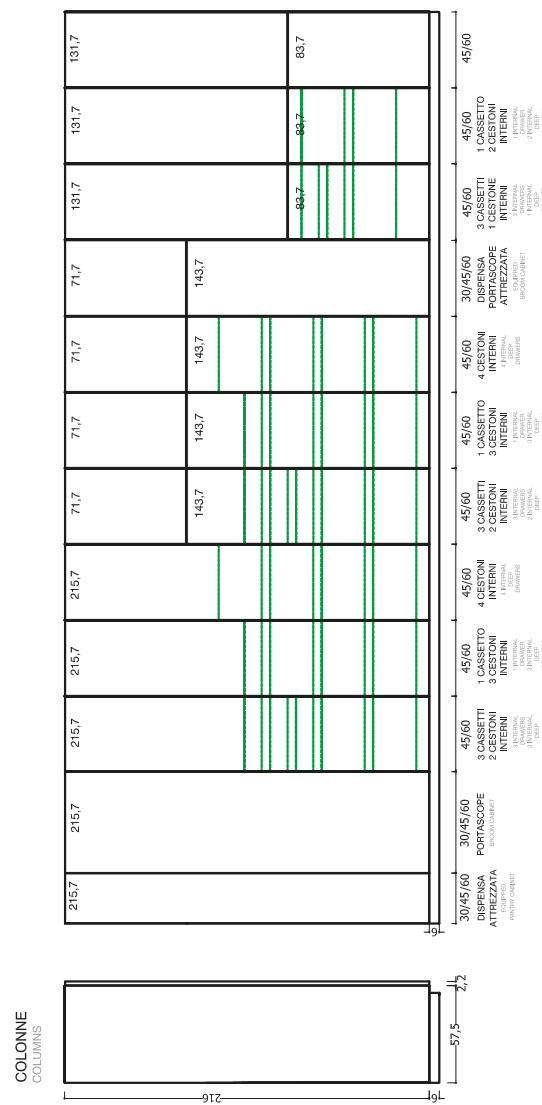
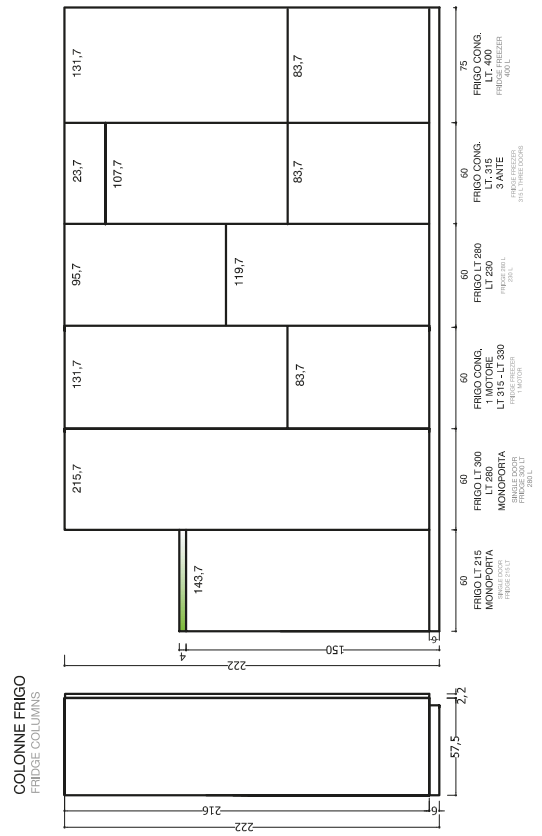





ANTE VETRO  
GLASS DOORS



telaio titanio con vetro satinato (opz.TISAT)  
titanium frame with satin glass (opt.TISAT)

telaio titanio con vetro bronzo (opz.TIBRZ)  
titanium frame with bronze glass (opt.TIBRZ)

telaio titanio con vetro fumè (opz.TIFUM)  
titanium frame with fumè glass (opt.TIFUM)

telaio urban con vetro satinato (opz.GISAT)  
urban frame with satin glass (opt.GISAT)

telaio urban con vetro bronzo (opz.GIBRZ)  
urban frame with bronze glass (opt.GIBRZ)

telaio urban con vetro fumè (opz.GIFUM)  
urban frame with fumè glass (opt.GIFUM)



telaio silver con vetro satinato (opz.PISAT)  
silver frame with satin glass (opt.PISAT)

telaio silver con vetro bronzo (opz.PIBRZ)  
silver frame with bronze glass (opt.PIBRZ)

telaio silver con vetro fumè (opz.PIFUM)  
silver frame with fumè glass (opt.PIFUM)

COLORI STRUTTURA INTERNA IN NOBILITATO  
COLOURS FOR INTERNAL MELAMINE-COATED STRUCTURE



bianco (opz.001)  
white (opt.001)

visone (opz.948M)  
mink (opt.948M)

lavagna (opz.9620)  
slate grey (opt.9620)

fango (opz.8860)  
mud (opt.8860)

conchiglia (opz.8910)  
shell (opt.8910)

argilla (opz.9690)  
clay (opt.9690)

COLORI ANTE CHIUSE E PANNELLI FISSI FRONTALE E LATERALE  
COLOURS FOR DOORS AND FIXED FRONT LATERAL PANELS

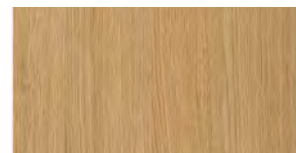

IMPIALLACCIATO WOOD per colori vedi pag.12-13  
WOOD VENEERED for colours see page 12-13



# PENSILI A COLORAZIONE INTEGRALE CON STRUTTURA FOLDING

## FULL COLOUR WALL UNITS WITH FOLDING CARCASS



colori per strutture e ante impiallacciate wood  
wood veneered colours for carcasses and doors

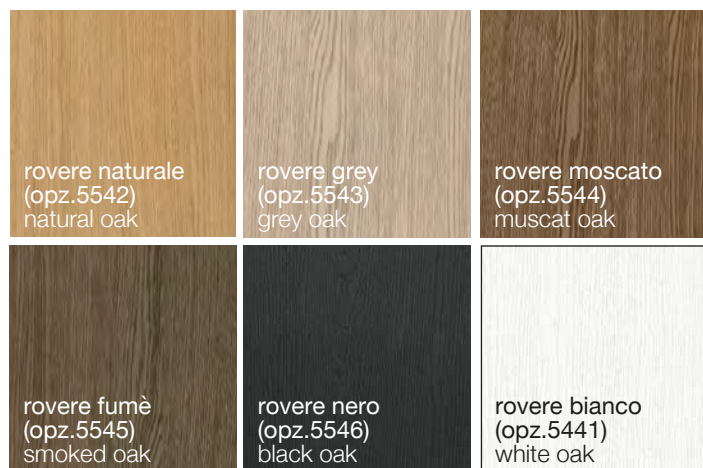

# MENSOLE IN LAMIERA VERNICIATA CON SCHIENALE NEI COLORI COME ANTE

PAINTED STEEL SHELVES WITH BACK PANEL SAME COLOURS AS DOORS

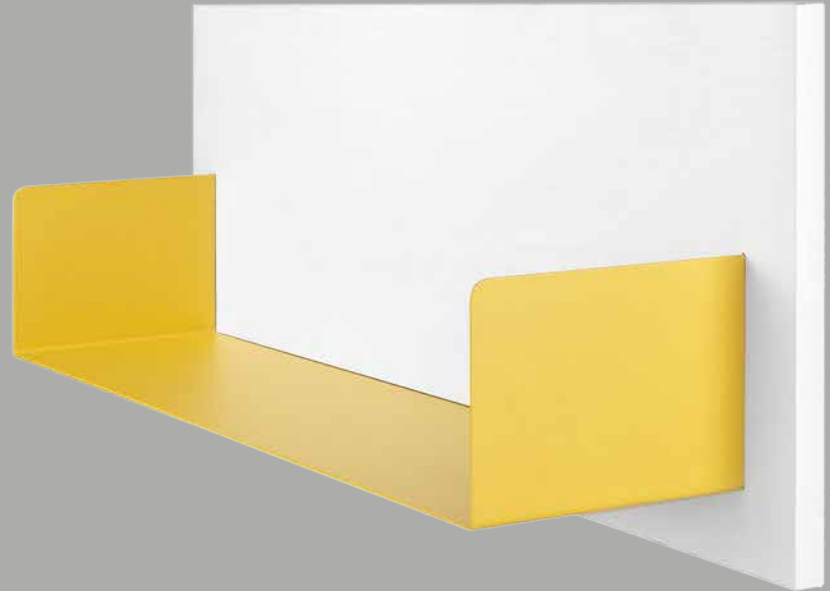
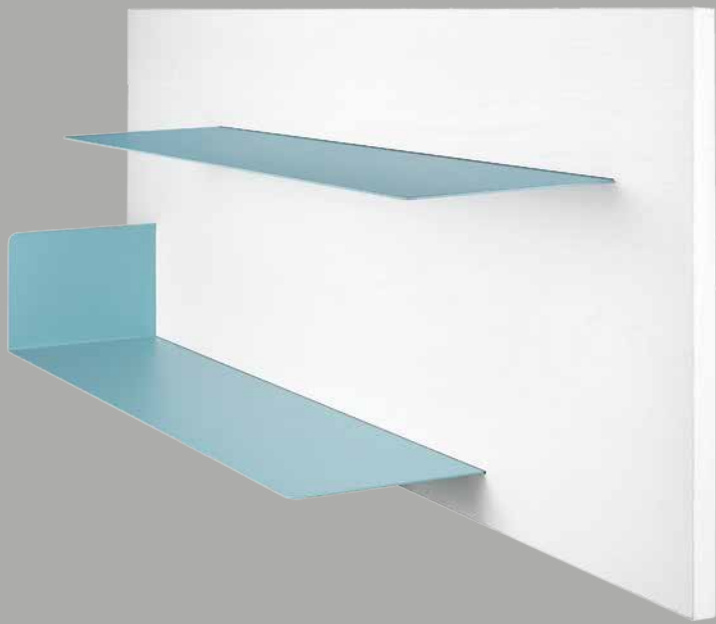

finiture mensole in lamiera verniciata a polvere opache  
steel shelves matt powder coated



# MOBILE DI FINITURA "SIDE"

"SIDE" FINISHING FURNITURE



## COLORI STRUTTURA IMPIALLACCIATI WOOD

CARCASS COLOURS WOOD VENEERED

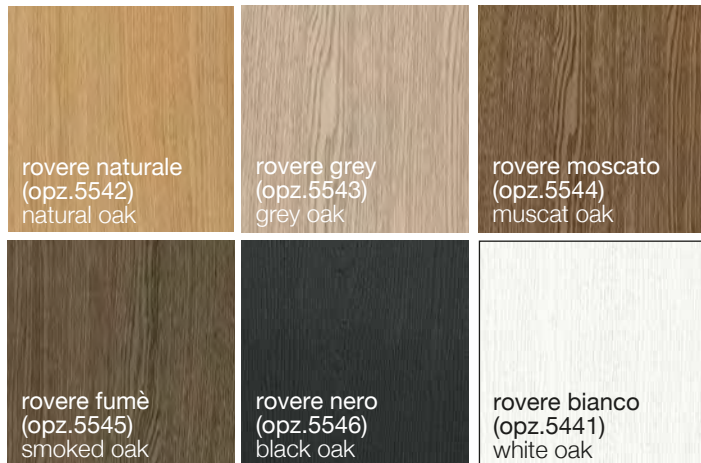

## COLORI DIVISORI VETRI

GLASS DIVIDERS COLOURS





# MOBILI LIVING “PLAN” COMPONENTI

“PLAN” LIVING MODULAR FURNITURE

---



## FINITURE ELEMENTI A GIORNO PER MOBILI LIVING “PLAN”

FINISHES FOR “PLAN” LIVING OPEN UNITS

COLORI LACCATI OPACHI (Catalogo “FINITURE LACCATE” Gruppo Lube)

MATT LACQUERED COLOURS (“LACQUERED FINISHES” Catalogue Gruppo Lube)

<p>bianco assoluto (opz.740S) absolute white</p>	<p>cenere (opz.9547) ash</p>	<p>grigio traffico (opz.9511) traffic grey</p>	<p>nebbia (opz.95F5) fog</p>	<p>argilla (opz.9503) clay</p>	<p>grigio bromo (opz.9533) bromine grey</p>	<p>nero seppia (opz.7897) cuttlefish ink</p>
<p>bianco caldo (opz.7401) warm white</p>	<p>polvere (opz.9539) dust</p>	<p>lino (opz.9513) linen</p>	<p>conchiglia (opz.7403) seashell</p>	<p>tortora (opz.8993) dove grey</p>	<p>platino (opz.7773) platinum</p>	<p>nocciola (opz.7775) walnut</p>
<p>grigio kenya (opz.9501) kenya grey</p>	<p>creta (opz.9515) clay</p>	<p>cuoio (opz.8897) leather</p>	<p>grigio reale (opz.95F3) royal grey</p>	<p>fumo (opz.9531) smoke</p>	<p>grigio quarzo (opz.95F7) quartz grey</p>	<p>grigio lava (opz.95F1) lava grey</p>
<p>grigio piombo (opz.9537) lead grey</p>	<p>bistro (opz.9535) bistro</p>	<p>verde bosco (opz.8468) forest green</p>	<p>azzurro nube (opz.8379) cloud blue</p>	<p>blu cristal (opz.8381) cristal blue</p>	<p>rosso persia (opz.8165) persia red</p>	<p>cannella (opz.8893) cinnamon</p>
<p>giallo zafferano (opz.8253) saffron yellow</p>						

# VIVI IL LIVING

LIVE THE LIVING

Con i nuovi pensili più profondi  
è facilissimo creare composizioni living  
adatte ad ogni spazio.

With new more deep wall units,  
it's easy to create lively  
furnishing compositions.





## COMPOSIZIONE L 305

COMPOSITION W 305



## COMPOSIZIONE L 423

COMPOSITION W 423



## COMPOSIZIONE L 305

COMPOSITION W 305

### COMPONENTI COMPONENTS

**Colonna 60 H 217 frigo-freezer 230 classe A+ con gola verticale e fianco come anta**

60 cm column H 217 fridge-freezer 230 class "A+" with vertical groove as doors and side

**Base 60**

60 cm base unit

**Base 60 forno multifunzione inox**

60 cm base unit for stainless steel multifunctional oven

**Piano cottura 60 4 gas inox con valvola**

60 cm stainless steel hob with 4 burners with safety valve

**Base 60 2 cassetti e cestone**

60 cm base unit with 2 drawers and deep drawer

**Sottolavello 60**

60 cm sink unit

**Lavello ad incasso 86 x 50 1 vasca inox**

86x50 cm built-in sink with 1 stainless steel bowl

**Top 240 P 61 in laminato H 4**

240 cm laminate worktop D 61 H 4

**Pensile 60 H 72**

60 cm wall unit H 72

**Cappa 60 "Mod. 29" H 72**

60 cm hood "Mod.29" H 72

**Pensile 60 H 72**

60 cm wall unit H 72

**Scolapiatti 60 H 72**

60 cm plate rack H 72

**Asta appendipensili ml 4**

4 lm wall unit fixing strip

**(Elettrodomestici Hotpoint )**  
(Hotpoint appliances)

### VERSIONI VERSIONS

**LUX**

**Impiallacciato**

Veneered

**NECK**

**Impiallacciato**

Veneered

## COMPOSIZIONE L 423

COMPOSITION W 423

### COMPONENTI COMPONENTS

**Colonna 60 H 217 frigo-freezer 315 classe A+**

60 cm column H 217 fridge-freezer 315 class "A+"

**Colonna 60 H 217 forno multifunzione inox**

60 cm column H 217 for stainless steel multifunctional oven

**Base 60**

60 cm base unit

**Piano cottura 75 5 gas inox con valvola**

75 cm stainless steel hob with 5 burners with safety valve

**Base 90 2 cassetti e cestone predisposta piano cottura**

90 cm base unit with 2 drawers and deep drawers configured for hob

**Base 60**

60 cm base unit

**Sottolavello 90**

90 cm sink unit

**Lavello ad incasso 86 x 50 1 vasca inox**

86x50 cm built-in sink with 1 stainless steel bowl

**Top 300 P 61 in laminato H 4**

300 cm laminate worktop D 61 H 4

**Pensile 60 H 72**

60 cm wall unit H 72

**Cappa 90 "STILO SMART" inox**

90 cm "STILO SMART" stainless steel hood

**Pensile 60 H 72**

60 cm wall unit H 72

**Scolapiatti 90 H 72**

90 cm plate rack H 72

**Asta appendipensili ml 4**

4 lm wall unit fixing strip

**(Elettrodomestici Hotpoint)**  
(Hotpoint appliances)

### VERSIONI VERSIONS

**LUX**

**Impiallacciato**

Veneered

**NECK**

**Impiallacciato**

Veneered

## COMPOSIZIONE L 300

COMPOSITION W 300



## COMPOSIZIONE L 420

COMPOSITION W 420





## COMPOSIZIONE L 300

COMPOSITION W 300

### COMPONENTI COMPONENTS

#### Colonna 60 H 217 frigo-freezer 230 classe A+

60 cm column H 217 fridge-freezer 230 class "A+"

#### Base 60

60 cm base unit

#### Base 60 forno multifunzione inox

60 cm base unit for stainless steel multifunctional oven

#### Piano cottura 60 4 gas inox con valvola

60 cm stainless steel hob with 4 burners with safety valve

#### Base 60 2 cassetti e cestone

60 cm base unit with 2 drawers and deep drawer

#### Sottolavello 60

60 cm sink unit

#### Lavello ad incasso 86 x 50 1 vasca inox

86x50 cm built-in sink with 1 stainless steel bowl

#### Top 240 P 61 in laminato H 4

240 cm laminate worktop D 61 H 4

#### Pensile 60 H 72

60 cm wall unit H 72

#### Cappa 60 aspirante estraibile H 63

60 cm hood slide-out ducting H 63

#### Pensile 60 H 72

60 cm wall unit H 72

#### Scolapiatti 60 H 72

60 cm plate rack H 72

#### Asta appendipensili ml 4

4 lm wall unit fixing strip

**(Elettrodomestici Hotpoint )**  
(Hotpoint appliances)

### VERSIONI VERSIONS

#### BRIDGE

#### Impiallacciato

Veneered

#### HEAD

#### Impiallacciato

Veneered

## COMPOSIZIONE L 420

COMPOSITION W 420

### COMPONENTI COMPONENTS

#### Colonna 60 H 217 frigo-freezer 315 classe A+

60 cm column H 217 fridge-freezer 315 class "A+"

#### Colonna 60 H 217 forno multifunzione inox

60 cm column H 217 for stainless steel multifunctional oven

#### Base 60

60 cm base unit

#### Piano cottura 75 5 gas inox con valvola

75 cm stainless steel hob with 5 burners with safety valve

#### Base 90 2 cassetti e cestone predisposta piano cottura

90 cm base unit with 2 drawers and deep drawers configured for hob

#### Base 60

60 cm base unit

#### Sottolavello 90

90 cm sink unit

#### Lavello ad incasso 86 x 50 1 vasca inox

86x50 cm built-in sink with 1 stainless steel bowl

#### Top 300 P 61 in laminato H 4

300 cm laminate worktop D 61 H 4

#### Pensile 60 H 72

60 cm wall unit H 72

#### Cappa 90 "STILO SMART" inox

90 cm "STILO SMART" stainless steel hood

#### Pensile 60 H 72

60 cm wall unit H 72

#### Scolapiatti 90 H 72

90 cm plate rack H 72

#### Asta appendipensili ml 4

4 lm wall unit fixing strip

**(Elettrodomestici Hotpoint)**  
(Hotpoint appliances)

### VERSIONI VERSIONS

#### BRIDGE

#### Impiallacciato

Veneered

#### HEAD

#### Impiallacciato

Veneered

# immagina **+PLUS**



immagina<sup>PLUS</sup>

LUX

IMMAGINA AMPLIA LA PROPRIA GAMMA DI ANTE  
AD APERTURA A GOLA INSERENDO NELLA COLLEZIONE  
LUX TRE NUOVI PROFILI :

“CURVO”, “AD ELLE”, “INCLINATO”.

TUTTI GARANTISCONO LA MASSIMA PERSONALIZZAZIONE  
DI COLORI E FINITURE CON INFINITE POSSIBILITÀ  
DI ABBINAMENTO.

IMMAGINA EXTENDS ITS RANGE OF FINGER RAIL  
OPENING DOORS INCLUDING IN THE LUX COLLECTION  
THREE NEW PROFILES: “CURVED”, “L-SHAPED”,  
“INCLINED”. THEY PROVIDE THE MAXIMUM  
CUSTOMIZATION FOR COLORS AND FINISHES, WITH  
ENDLESS MATCHING POSSIBILITIES.

anta con tre nuovi profili  
e maniglia a gola  
door with three new profiles  
and finger-rail





LA GOLA DELLE BASI E DELLE COLONNE PUÒ ESSERE IN DIVERSI COLORI LACCATI O IN ALLUMINIO FINITURA BRILL PER CREARE GIOCHI DI CROMIE E DARE UN DETTAGLIO PARTICOLARE ALLA PROPRIA CUCINA.

BASE UNITS AND COLUMNS FINGER RAILS ARE AVAILABLE IN VARIOUS LACQUERED COLOURS OR IN ALUMINIUM VERSION WITH BRILL FINISH, TO CREATE COLOUR EFFECTS AND ADD A DISTINCTIVE NOTE TO THE KITCHEN.

immagina<sup>PLUS</sup>

# Neck

anta con maniglia a gola  
door with finger-rail handle



NUOVE MANIGLIE CON FINITURA CROMATA,  
FINITURA ACCIAIO SATINATO E OSSIDATO,  
PER UN'ANTA DAL CARATTERE DECISO.

NEW HANDLES WITH CHROME,  
OR SATIN STEEL AND OXIDIZED FINISH,  
FOR A DOOR WITH DECIDED CHARACTER.

immagina<sup>PLUS</sup>

# Bridge

anta con maniglia frontale  
door with front handle



È UNA NUOVA MANIGLIA IN ALLUMINIO  
CHE GARANTISCE UN'OTTIMA PRESA.  
IL DESIGN È ESTREMAMENTE PULITO.

A NEW ALUMINIUM HANDLE  
FOR A GOOD GRIP.  
THE DESIGN IS VERY CLEAN.

immagina<sup>PLUS</sup>  
Head

anta con maniglia applicata in testa  
door with top-mounted handle



SP. 22 MM

## CARATTERISTICHE TECNICHE

### ANTE E FRONTALI CASSETTI

anta sp.22 mm costituita da un supporto di pannello di particelle di legno (conforme **US EPA TSCA Title VI**) nobilitato melaminico bordato in abs o polipropilene\* in tinta:

**finitura opaca cansiglio venatura verticale:** cansiglio bianco (opz.1561), cansiglio terra bruciata (opz.1562), cansiglio grigio fumo (opz.1563), cansiglio sabbia (opz.1564), cansiglio champagne (opz.1565)

**finitura opaca poro a registro venatura verticale:** larice baglia (opz.1826), larice laguna (opz.1827), larice vulcano (opz.1828), larice terra (opz.1829), noce (opz.2363)

**finitura ossidata:** nichel (opz.9660), platino (opz.9661), zinco (opz.9662)

**finitura spazzolata:** titanio (opz.9665), peltro (opz.9666)

**finitura opaca malta:** bianco cristallo (opz.7445), grigio nebbia (opz.9626), castoro (opz.8862), lavagna (opz.9627), juta (opz.8863)

**finitura matt:** bianco assoluto (opz.7441), bianco neve (opz.750), grigio sasso (opz.9650), grigio monzone (opz.9651), grigio notte (opz.9652), grigio velo (opz.9653), verde marino (opz.8402)

**finitura opaca marmorizzata:** marmo baron (opz.9632)

**finitura opaca materica:** cemento (opz.9633)

**finitura opaca sincro poro effetto laccato venatura orizzontale:** olmo bianco (opz.5001), olmo antracite (opz.5004)

**finitura opaca sincro poro effetto legno venatura verticale:** abete bianco (opz.4401), oak miele (opz.1361), oak neve (opz.1362), oak cognac (opz.1363)



\* **Tecnologia produttiva di elevata qualità trasmette al bordo un'alta resistenza ai prodotti acidi, solventi e raggi UV. Inoltre è un prodotto ecologico**

### PROFILI E GOLE VERSIONE LUX

**di serie:** profilo curvo brill (opz.PC412), per gola piatta brill (opz.412P)  
a richiesta: profilo curvo per gola ad "ELLE"



a richiesta: profilo ad elle per gola piatta  
profilo ad elle per gola ad "ELLE"



a richiesta: profilo inclinato per gola piatta  
profilo inclinato per gola "ELLE"



### PROFILO E GOLA VERSIONE NECK

anta squadrata senza profilo con gola "ELLE"



**N.B.:** per le finiture profili e gole vedi pag.39

### MANIGLIE

vedi pag.48-61



# CARATTERISTICHE TECNICHE

## STRUTTURE

### **FINITURA OPACA CANSIGLIO VENATURA VERTICALE**

**ANTE:** bianco, grigio fumo, champagne  
di serie : nobilitato visone (opz.948M) schiena e ripiano visone (opz.948M)

**ANTE:** sabbia, terra bruciata  
di serie : nobilitato fango (opz.8860) schiena e ripiano fango (opz.8860)

### **FINITURA OPACA PORO A REGISTRO VENATURA VERTICALE**

**ANTE:** noce, larice terra  
di serie : nobilitato fango (opz.8860) schiena e ripiano fango (opz.8860)

**ANTA:** larice baglia  
di serie : nobilitato conchiglia (opz.8910) schiena e ripiano conchiglia (opz.8910)

**ANTA:** larice vulcano  
di serie : nobilitato lavagna (opz.9620) schiena e ripiano lavagna (opz.9620)

**ANTA:** larice laguna  
di serie : nobilitato visone (opz.948M) schiena e ripiano visone (opz.948M)

### **FINITURA OSSIDATA**

**ANTA:** zinco  
di serie : nobilitato lavagna (opz.9620) schiena e ripiano lavagna (opz.9620)

**ANTA:** platino  
di serie : nobilitato visone (opz.948M) schiena e ripiano visone (opz.948M)

**ANTA:** nichel  
di serie : nobilitato conchiglia (opz.8910) schiena e ripiano conchiglia (opz.8910)

### **FINITURA SPAZZOLATA**

**ANTA:** titanio  
di serie : nobilitato lavagna (opz.9620) schiena e ripiano lavagna (opz.9620)

**ANTA:** peltro  
di serie : nobilitato visone (opz.948M) schiena e ripiano visone (opz.948M)

### **FINITURA OPACA MALTA**

**ANTA:** bianco cristallo  
di serie : nobilitato bianco (opz.001) schiena e ripiano bianco (opz.001)

**ANTE:** castoro, juta  
di serie : nobilitato fango (opz.8860) schiena e ripiano fango (opz.8860)

**ANTE:** lavagna, grigio nebbia  
di serie : nobilitato lavagna (opz.9620) schiena e ripiano lavagna (opz.9620)

### **FINITURA MATT**

**ANTE:** bianco assoluto, grigio monzone, verde marino  
di serie : nobilitato bianco (opz.001) schiena e ripiano bianco (opz.001)

**ANTA:** grigio notte  
di serie : nobilitato lavagna (opz.9620) schiena e ripiano lavagna (opz.9620)

**ANTE:** bianco neve, grigio sasso, grigio velo  
di serie : nobilitato visone (opz.948M) schiena e ripiano visone (opz.948M)

### **FINITURA OPACA MARMORIZZATA**

**ANTA:** marmo baron  
di serie : nobilitato argilla (opz.9690) schiena e ripiano argilla (opz.9690)

### **FINITURA OPACA MATERICA**

**ANTA:** cemento  
di serie : nobilitato bianco (opz.001) schiena e ripiano bianco (opz.001)

### **FINITURA SINCRO PORO EFFETTO LACCATO VENATURA ORIZZONTALE**

**ANTA:** olmo bianco  
di serie : nobilitato bianco (opz.001) schiena e ripiano bianco (opz.001)

**ANTA:** olmo antracite  
di serie : nobilitato lavagna (opz.9620) schiena e ripiano lavagna (opz.9620)

### **FINITURA SINCRO PORO EFFETTO LEGNO VENATURA VERTICALE**

**ANTE:** abete bianco, oak miele, oak cognac  
di serie : nobilitato visone (opz.948M) schiena e ripiano visone (opz.948M)

**ANTA:** oak neve  
di serie : nobilitato argilla (opz.9690) schiena e ripiano argilla (opz.9690)

## MENSOLE

vedi pag.62-63

## ZOCCOLI

vedi pag.64



I PRODOTTI IN LEGNO SONO CONFORMI AL REGOLAMENTO (US EPA TSCA Title VI) RIGUARDO ALL'EMISSIONE DI FORMALDEIDE





# Melamine

# Lux Neck Bridge Head

TH. 22 MM

---

## TECHNICAL FEATURES

---

### DOORS AND DRAWER FRONTS

22 mm thick door made of a melamine-coated wood particle board panel (compliant with **US EPA TSCA Title VI**) with ABS or polypropylene edging\* in the following colours:

**matt cansiglio finish with vertical grain:** white cansiglio (opt.1561), scorched earth cansiglio (opt.1562), smoke grey cansiglio (opt.1563), sand cansiglio (opt.1564), champagne cansiglio (opt.1565)

**matt finish with register pore and vertical grain:** baglia larch (opt.1826), lagoon larch (opt.1827), volcano larch (opt.1828), earth larch (opt.1829), walnut (opt.2363)

**oxidised finish:** nickel (opt.9660), platinum (opt.9661), zinc (opt.9662)

**brushed finish:** titanium (opt.9665), pewter (opt.9666)

**matt mortar finish:** crystal white (opt.7445), fog grey (opt.9626), beaver (opt.8862), slate grey (opt.9627), jute (opt.8863)

**matt finish:** absolute white (opt.7441), snow white (opt.750), pebble grey (opt.9650), monsoon grey (opt.9651), midnight grey (opt.9652), veil grey (opt.9653), sea green (opt.8402)

**matt marbled finish:** baron marble (opt.9632)

**matt textured finish:** cement (opt.9633)

**matt sync-pore finish with lacquered effect and horizontal grain:** white elm (opt.5001), anthracite elm (opt.5004)

**matt sync-pore finish with vertical grain wood effect:** white fir (opt.4401), honey oak (opt.1361), snow oak (opt.1362), cognac oak (opt.1363)



\* **High quality manufacturing technology, gives the edging a high level of resistance to acids, solvents and UV rays. It is also an ecological product.**

### PROFILES AND FINGER RAILS LUX VERSION

**standard:** brill curved profile (opt.PC412), for flat finger rail brill (opt.412P)  
on request: curved profile for "L" shaped finger rail



on request: L shaped profile for flat finger rail  
L shaped profile for "L" shaped finger rail



on request: inclined profile for flat finger rail  
inclined profile "L" shaped finger rail



### PROFILE AND FINGER RAIL NECK VERSION

square door without profile with "L" shaped finger rail



**NOTE:** for the profile and finger rail finishes see page 39

### HANDLES

see page 48-61

## TECHNICAL FEATURES

### CARCASSES

#### **MATT CANSIGLIO FINISH WITH VERTICAL GRAIN**

**DOORS: white, smoke grey, champagne**  
standard: melamine-coated mink (opt.948M), mink back panel and shelf (opt.948M)

**DOORS: sand, scorched earth**  
standard: melamine-coated mud (opt.8860) back panel and shelf mud (opt.8860)

#### **MATT FINISH WITH REGISTER PORE AND VERTICAL GRAIN**

**DOORS: walnut, earth larch**  
standard: melamine-coated mud (opt.8860) back panel and shelf mud (opt.8860)

**DOOR: baglia larch**  
standard: melamine-coated shell (opt.8910) back panel and shelf shell (opt.8910)

**DOOR: volcano larch**  
standard: melamine-coated slate grey (opt.9620) back panel and shelf slate grey (opt.9620)

**DOOR: lagoon larch**  
standard: melamine-coated mink (opt.948M), mink back panel and shelf (opt.948M)

#### **OXIDISED FINISH**

**DOOR: zinc**  
standard: melamine-coated slate grey (opt.9620) back panel and shelf slate grey (opt.9620)

**DOOR: platinum**  
standard: melamine-coated mink (opt.948M), mink back panel and shelf (opt.948M)

**DOOR: nickel**  
standard: melamine-coated shell (opt.8910) back panel and shelf shell (opt.8910)

#### **BRUSHED FINISH**

**DOOR: titanium**  
standard: melamine-coated slate grey (opt.9620) back panel and shelf slate grey (opt.9620)

**DOOR: pewter**  
standard: melamine-coated mink (opt.948M), mink back panel and shelf (opt.948M)

#### **MATT MORTAR FINISH**

**DOOR: crystal white**  
standard: melamine-coated white (opt.001), white back panel and shelf (opt.001)

**DOORS: beaver, jute**  
standard: melamine-coated mud (opt.8860) back panel and shelf mud (opt.8860)

**DOORS: slate grey, fog grey**  
standard: melamine-coated slate grey (opt.9620) back panel and shelf slate grey (opt.9620)

#### **MATT FINISH**

**DOORS: absolute white, monsoon grey, sea green**  
standard: melamine-coated white (opt.001), white back panel and shelf (opt.001)

**DOOR: midnight grey**  
standard: melamine-coated slate grey (opt.9620) back panel and shelf slate grey (opt.9620)

**DOORS: snow white, pebble grey, veil grey**  
standard: melamine-coated mink (opt.948M), mink back panel and shelf (opt.948M)

#### **MATT MARBLED FINISH**

**DOOR: baron marble**  
standard: melamine-coated clay (opt.9503) clay back panel and shelf (opt.9503)

#### **MATT TEXTURED FINISH**

**DOOR: cement**  
standard: melamine-coated white (opt.001), white back panel and shelf (opt.001)

#### **SYNC-PORE FINISH WITH LACQUERED EFFECT AND HORIZONTAL GRAIN**

**DOOR: white elm**  
standard: melamine-coated white (opt.001), white back panel and shelf (opt.001)

**DOOR: anthracite elm**  
standard: melamine-coated slate grey (opt.9620) back panel and shelf slate grey (opt.9620)

#### **SYNC-PORE FINISH WITH WOOD EFFECT AND VERTICAL GRAIN**

**DOORS: white fir, honey oak, cognac oak**  
standard: melamine-coated mink (opt.948M), mink back panel and shelf (opt.948M)

**DOOR: snow oak**  
standard: melamine-coated clay (opt.9503) clay back panel and shelf (opt.9503)

### SHELVES

[see page 62-63](#)

### PLINTHS

[see page 64](#)

WOODEN PRODUCTS ARE COMPLIANT WITH REGULATIONS (US EPA TSCA Title VI) GOVERNING FORMALDEHYDE EMISSIONS



# Melaminico-Melamine

Lux  
Neck  
Bridge  
Head

SP. 22 MM TH. 22 MM

---

ante finitura opaca cansiglio

doors with cansiglio matt finish



cansiglio bianco (opz.1561),  
venatura verticale  
cansiglio white (opt.1561),  
vertical grain



cansiglio terra bruciata (opz.1562),  
venatura verticale  
cansiglio scorched earth  
(opt.1562), vertical grain

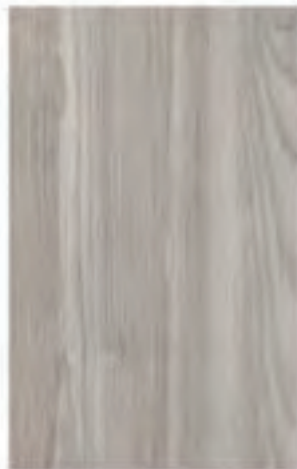

cansiglio grigio fumo (opz.1563),  
venatura verticale  
cansiglio smoke grey (opt.1563),  
vertical grain



cansiglio sabbia (opz.1564),  
venatura verticale  
cansiglio sand (opt.1564),  
vertical grain

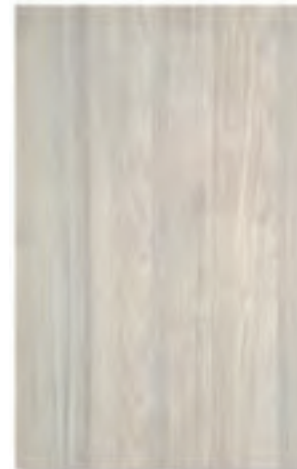

cansiglio champagne (opz.1565),  
venatura verticale  
cansiglio champagne  
(opt.1565), vertical grain

ante finitura opaca poro aperto a registro doors with register open-pore finish



larice baglia (opz.1826),  
venatura verticale  
baglia larch (opt.1826),  
vertical grain



larice laguna (opz.1827),  
venatura verticale  
lagoon larch (opt.1827),  
vertical grain



larice vulcano (opz.1828),  
venatura verticale  
volcano larch (opt.1828),  
vertical grain



larice terra (opz.1829),  
venatura verticale  
earth larch (opt.1829),  
vertical grain



noce (opz.2363),  
venatura verticale  
walnut (opt.2363),  
vertical grain

anta finitura opaca materica door with textured matt finish



cemento (opz.9633)  
cement (opt.9633)

# Melaminico-Melamine

SP. 22 MM TH. 22 MM

Lux  
Neck  
Bridge  
Head

ante finitura opaca malta

doors with mortar matt finish



bianco cristallo (opz.7445)  
cristal white (opt.7445)



grigio nebbia (opz.9626)  
fog grey (opt.9626)



castoro (opz.8862)  
beaver (opt.8862)



lavagna (opz.9627)  
slate grey (opt.9627)



juta (opz.8863)  
jute (opt.8863)

ante finitura matt doors with matt finish



bianco assoluto (opz.7441)  
absolute white (opt.7441)



bianco neve (opz.750)  
snow white (opt.750)



grigio sasso (opz.9650)  
pebble grey (opt.9650)



verde marino (opz.8402)  
sea green (opt.8402)



grigio monzone (opz.9651)  
monsoon grey (opt.9651)



grigio notte (opz.9652)  
midnight grey (opt.9652)



grigio velo (opz.9653)  
veil grey (opt.9653)

incollaggio laser

laser gluing

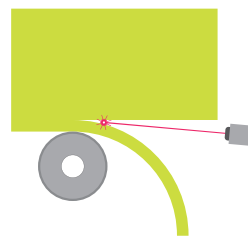

Questa moderna tecnica di incollaggio consiste nella fusione del bordo sul pannello attraverso una fonte laser, grazie alla quale pannello e bordo diventano una cosa sola.

La saldatura è permanente e senza fuga ed elimina così non solo i difetti estetici dovuti ai residui di colla, ma anche la formazione di sporco e di ingiallimento garantendo un'estetica impeccabile che dura nel tempo.

This modern gluing technique consists in the fusion of the edge on the panel through a laser source, thanks to which panel and edge become one thing. The welding is permanent and without leakage and thus eliminates not only the aesthetic defects due to the residual glue, but also the formation of dirt and yellowing ensuring impeccable and lasting aesthetics.

# Melaminico-Melamine

Lux  
Neck  
Bridge  
Head

SP. 22 MM TH. 22 MM

---

anta finitura opaca marmorizzata

door with marbled matt finish



marmo baron (opz.9632)  
baron marble (opt.9632)

ante finitura ossidata doors with oxidized finish



nichel (opz.9660)  
nickel (opt.9660)



platino (opz.9661)  
platinum (opt.9661)



zinco (opz.9662)  
zinc (opt.9662)

ante finitura spazzolata doors with brushed finish



peltro (opz.9666)  
pewter (opt.9666)



titanio (opz.9665)  
titanium (opt.9665)



# Melaminico-Melamine

SP. 22 MM TH. 22 MM

ante finitura opaca sincro poro effetto laccato  
doors with sync pore lacquered effect matt finish



\* olmo bianco (opz.5001),  
venatura orizzontale  
white elm (opt.5001),  
horizontal grain



olmo antracite (opz.5004),  
venatura orizzontale  
anthracite elm (opt.5004),  
horizontal grain

ante finitura opaca sincro poro effetto legno  
doors with sync pore wood effect matt finish



abete bianco (opz.4401),  
venatura verticale  
white fir (opt.4401),  
vertical grain



oak miele (opz.1361),  
venatura verticale  
honey oak (opt.1361),  
vertical grain



oak neve (opz.1362),  
venatura verticale  
snow oak (opt.1362),  
vertical grain



oak cognac (opz.1363),  
venatura verticale  
cognac oak (opt.1363),  
vertical grain

\* incollaggio laser  
laser gluing

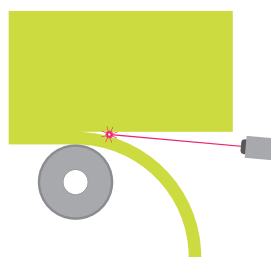

Questa moderna tecnica di incollaggio consiste nella fusione del bordo sul pannello attraverso una fonte laser, grazie alla quale pannello e bordo diventano una cosa sola.

La saldatura è permanente e senza fuga ed elimina così non solo i difetti estetici dovuti ai residui di colla, ma anche la formazione di sporco e di ingiallimento garantendo un'estetica impeccabile che dura nel tempo.

This modern gluing technique consists in the fusion of the edge on the panel through a laser source, thanks to which panel and edge become one thing. The welding is permanent and without leakage and thus eliminates not only the aesthetic defects due to the residual glue, but also the formation of dirt and yellowing ensuring impeccable and lasting aesthetics.

Lux  
Neck  
Bridge  
Head

## CARATTERISTICHE TECNICHE

### ANTE E FRONTALI CASSETTI

anta sp.22 mm con pannello in MDF (conforme US EPA TSCA Title VI) sp.22 mm fronte esterno laccato superopaco (2 gloss) ciclo di verniciatura a raggi UV retro melaminico abbinato alla parte frontale, laccato in 4 lati polipropilene\* nei colori opachi: bianco (opz.7405), antracite (opz.9558), grigio arena (opz.9521), ardesia (opz.9525), rosso vino (opz.8163), desert (opz.8941), bianco neve (opz.7407), verde malga (opz.8477), polvere (opz.9529), nero (opz.7895), blu cobalt (opz. 8383)

anta sp.22 mm con pannello in MDF (conforme US EPA TSCA Title VI) sp.22 mm fronte esterno laccato extralucido (92 gloss), ciclo di verniciatura a raggi UV retro melaminico abbinato alla parte frontale, bordato in 4 lati polipropilene\* nei colori lucidi: bianco (opz.7406), antracite (opz.9559), grigio arena (opz.9522), polvere (opz.9530), ardesia (opz.9526), desert (opz.8942), nero (opz.7896)



\* Tecnologia produttiva di elevata qualità trasmette al bordo un'alta resistenza ai prodotti acidi, solventi e raggi UV. Inoltre è un prodotto ecologico

### MANUTENZIONE E PULIZIA

Si consiglia di utilizzare un panno in microfibra inumidito con acqua e sapone neutro. È vietato l'utilizzo dei prodotti contenenti: ammoniacca, alcool, candeggina o abrasivi. Devono essere evitati anche i detergenti aggressivi tipo sgrassanti o similari, perchè possono danneggiare la superficie verniciata.

### PROFILI E GOLE VERSIONE LUX

di serie: profilo curvo brill (opz.PC412), per gola piatta brill (opz.412P)  
a richiesta: profilo curvo per gola ad "ELLE"



a richiesta: profilo ad elle per gola piatta  
profilo ad elle per gola ad "ELLE"



a richiesta: profilo inclinato per gola piatta  
profilo inclinato per gola "ELLE"



### PROFILO E GOLA VERSIONE NECK

anta squadrata senza profilo con gola "ELLE"



N.B.: per le finiture profili e gole vedi pag.39

### MANIGLIE

vedi pag.48-61

# CARATTERISTICHE TECNICHE

## STRUTTURE

**ANTA:** bianco  
nobilitato bianco (opz.001) schiena e ripiano bianco (opz.001)

**ANTE:** polvere, verde malga, desert  
nobilitato conchiglia (opz.8910) schiena e ripiano conchiglia (opz.8910)

**ANTE:** bianco neve, rosso vino, grigio arena  
nobilitato visone (opz.948M) schiena e ripiano visone (opz.948M)

**ANTE:** antracite, ardesia, nero  
nobilitato lavagna (opz.9620) schiena e ripiano lavagna (opz.9620)



## MENSOLE

vedi pag.62-63

## ZOCCOLI

vedi pag.64

I PRODOTTI IN LEGNO SONO CONFORMI AL REGOLAMENTO (US EPA TSCA Title VI) RIGUARDO ALL'EMISSIONE DI FORMALDEIDE



TH. 22 MM

## TECHNICAL FEATURES

### DOORS AND DRAWER FRONTS

22 mm thick door with panel in MDF (compliant with US EPA TSCA Title VI) 22 mm thick exterior front in super-matt lacquer (2 gloss) UV ray painting cycle melamine-coated rear matching the front with 4 edges in polypropylene\* in the following matt colours: white (opt.7405), anthracite (opt.9558), arena grey (opt.9521), slate grey (opt.9525), wine red (opt.8163), desert (opt.8941), snow white (opt.7407), alpine green (opt.8477), dust (opt.9529), black (opt.7895), cobalt blue (opt. 8383)

22 mm thick door with panel in MDF (compliant with US EPA TSCA Title VI) 22 mm thick exterior front in hi-gloss lacquer (92 gloss) UV ray painting cycle melamine-coated rear matching the front with 4 edges in polypropylene\* in the following gloss colours: white (opt.7406), anthracite (opt.9559), arena grey (opt.9522), dust (opt.9530), slate grey (opt.9526), desert (opt.8942), black (opt.7896)



\* High quality manufacturing technology, gives the edging a high level of resistance to acids, solvents and UV rays. It is also an ecological product.

### MAINTENANCE AND CLEANING

We recommend using a microfiber cloth dampened with water and neutral soap. It is forbidden the use of products containing: ammonia, alcohol, bleach or abrasives. Aggressive detergents such as degreasers or similar must also be avoided, as they can damage the painted surface.

### PROFILES AND FINGER RAILS LUX VERSION

standard: brill curved profile (opt.PC412), for flat finger rail brill (opt.412P)  
on request: curved profile for "L" shaped finger rail



on request: L shaped profile for flat finger rail  
L shaped profile for "L" shaped finger rail



on request: inclined profile for flat finger rail  
inclined profile "L" shaped finger rail

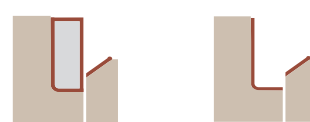

### PROFILE AND FINGER RAIL NECK VERSION

square door without profile with "L" shaped finger rail



NOTE: for the profile and finger rail finishes see page 39

### HANDLES

see page 48-61

## TECHNICAL FEATURES

---

### CARCASSES

**DOOR: white**

white chipboard (opt.001), white back panel and shelf (opt.001)

**DOORS: dust, alpine green, desert**

melamine-coated shell (opt.8910) back panel and shelf shell (opt.8910)

**DOORS: snow white, wine red, arena grey**

mink chipboard (opt.948M), mink back panel and shelf (opt.948M)

**DOORS: anthracite, slate grey, black**

slateboard grey chipboard (opt.9620), slateboard grey back panel and shelf (opt.9620)

---

### SHELVES

see page 62-63

---

### PLINTHS

see page 64

WOODEN PRODUCTS ARE COMPLIANT WITH REGULATIONS (US EPA TSCA Title VI) GOVERNING FORMALDEHYDE EMISSIONS





# Laccato-Lacquered <sup>NEW</sup>

SP. 22 MM TH. 22 MM

ante finitura opaca  
doors with matt finish

**L**UX cod. **G48**  
**N**eck cod. **G43**  
**B**ridge cod. **296**  
**H**ead cod. **297**

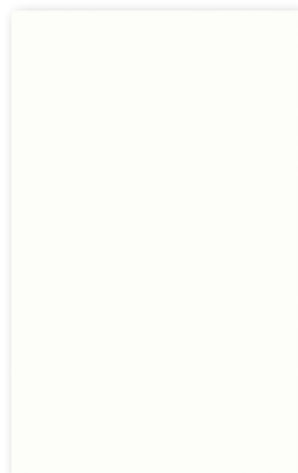

bianco (opz.7405)  
white (opt.7405)



antracite (opz.9558)  
anthracite (opt.9558)

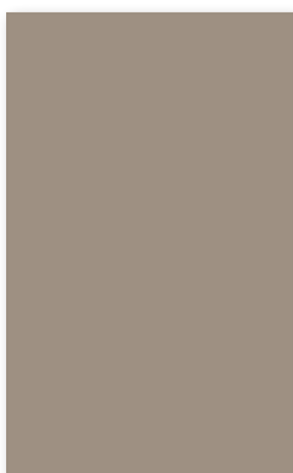

grigio arena (opz.9521)  
arena grey (opt.9521)



rosso vino (opz.8163)  
wine red (opt.8163)

N.B.: disponibile da gennaio 2019  
Note: available from January 2019

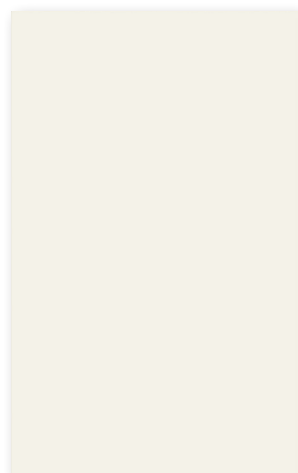

bianco neve (opz.7407)  
snow white (opt.7407)



verde malga (opz.8477)  
alpine green (opt.8477)

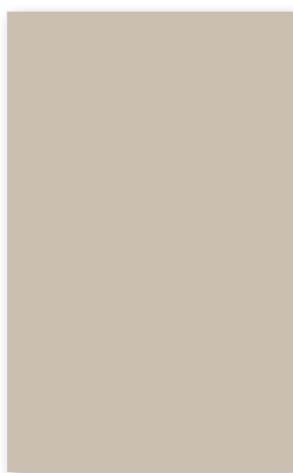

desert (opz.8941)  
desert (opt.8941)

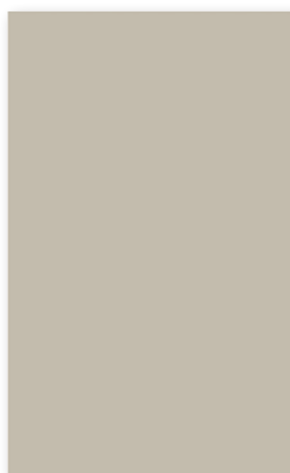

polvere (opz.9529)  
dust (opt.9529)



ardesia (opz.9525)  
slate grey (opt.9525)

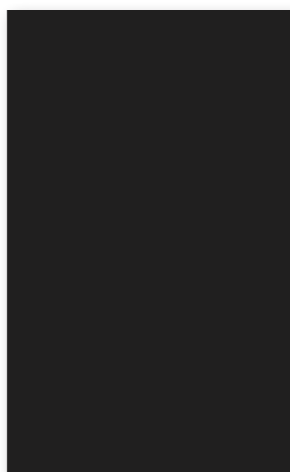

nero (opz.7895)  
black (opt.7895)



**NEW**  
\*blu cobalto (opz.8383)  
cobalt blue (opt.8383)

## incollaggio laser laser gluing

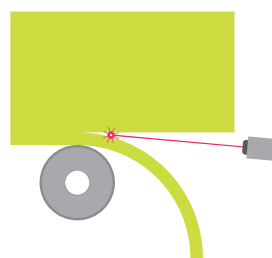

Questa moderna tecnica di incollaggio consiste nella fusione del bordo sul pannello attraverso una fonte laser, grazie alla quale pannello e bordo diventano una cosa sola. La saldatura è permanente e senza fuga ed elimina così non solo i difetti estetici dovuti ai residui di colla, ma anche la formazione di sporco e di ingiallimento garantendo un'estetica impeccabile che dura nel tempo.

This modern gluing technique consists in the fusion of the edge on the panel through a laser source, thanks to which panel and edge become one thing. The welding is permanent and without leakage and thus eliminates not only the aesthetic defects due to the residual glue, but also the formation of dirt and yellowing ensuring impeccable and lasting aesthetics.

\*N.B.: disponibile a partire da gennaio 2022  
Note: available from January 2022

# Laccato-Lacquered <sup>NEW</sup>

SP. 22 MM TH. 22 MM

---

ante finitura lucida  
doors with glossy finish

LUX  
Neck  
Bridge cod.  
Head



bianco (opz.7406)  
white (opt.7406)



antracite (opz.9559)  
anthracite (opt.9559)



grigio arena (opz.9522)  
arena grey (opt.9522)



polvere (opz.9530)  
dust (opt.9530)

N.B.: disponibile da gennaio 2019  
Note: available from January 2019



ardesia (opz.9526)  
slate grey (opt.9526)



desert (opz.8942)  
desert (opt.8942)



nero (opz.7896)  
black (opt.7896)

## incollaggio laser laser gluing

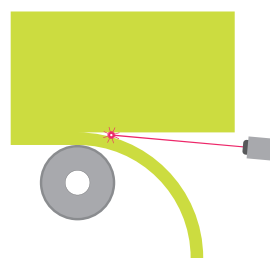

Questa moderna tecnica di incollaggio consiste nella fusione del bordo sul pannello attraverso una fonte laser, grazie alla quale pannello e bordo diventano una cosa sola.

La saldatura è permanente e senza fuga ed elimina così non solo i difetti estetici dovuti ai residui di colla, ma anche la formazione di sporco e di ingiallimento garantendo un'estetica impeccabile che dura nel tempo.

This modern gluing technique consists in the fusion of the edge on the panel through a laser source, thanks to which panel and edge become one thing. The welding is permanent and without leakage and thus eliminates not only the aesthetic defects due to the residual glue, but also the formation of dirt and yellowing ensuring impeccable and lasting aesthetics.

## CARATTERISTICHE TECNICHE

### ANTE E FRONTALI CASSETTI

anta sp.22 mm costituita da un supporto di pannello di particelle di legno (conforme US EPA TSCA Title VI) sp.19 mm rivestito: sulla parte esterna in acrilico sp.1,4 mm finitura opaca (5 gloss), nella parte interna con krystal opaco sp.1,2 mm in tinta con l'esterno, bordata sui 4 lati con bordo in ABS opaco sp.1 mm in tinta, disponibile nei colori: bianco assoluto (opz.7495), bianco caldo (opz.7497), tortora chiaro (opz.896A), visone (opz.946A), grigio alaska (opz.9581), grigio reale (opz.9565), grigio singapore (opz.9575), verde felce (opz.8457), rosso veneziano (opz.8147), argilla (opz.9573), grigio piombo (opz.9569), grigio ombra (opz.9585), blu fumo (opz.8353)

anta sp.22 mm costituita da un supporto di pannello di particelle di legno (conforme US EPA TSCA Title VI) sp.19 mm rivestito: sulla parte esterna in acrilico sp.1,4 mm finitura lucida (90 gloss), nella parte interna con krystal lucido sp.1,2 mm in tinta con l'esterno, bordata sui 4 lati con bordo in ABS lucido sp.1 mm in tinta, disponibile nei colori: bianco assoluto (opz.7496), bianco caldo (opz.7498), tortora chiaro (opz.895A), visone (opz.947A), grigio alaska (opz.9582), grigio reale (opz.9566), grigio singapore (opz.9576), verde felce (opz.8458), argilla (opz.9574), grigio piombo (opz.9570), grigio ombra (opz.9586), blu fumo (opz.8354)

### PROFILI E GOLE VERSIONE LUX

di serie: profilo curvo brill (opz.PC412), per gola piatta brill (opz.412P)  
a richiesta: profilo curvo per gola ad "ELLE"



a richiesta: profilo ad elle per gola piatta  
profilo ad elle per gola ad "ELLE"



a richiesta: profilo inclinato per gola piatta  
profilo inclinato per gola "ELLE"



### PROFILO E GOLA VERSIONE NECK

anta squadrata senza profilo con gola "ELLE"



N.B.: per le finiture profili e gole vedi pag.39

### MANIGLIE

vedi pag.48-61

# CARATTERISTICHE TECNICHE

## STRUTTURE

**ANTA: bianco assoluto**  
nobilitato bianco (opz.001) schiena e ripiano bianco (opz.001)

**ANTA: tortora chiaro**  
nobilitato conchiglia (opz.8910) schiena e ripiano conchiglia (opz.8910)

**ANTE: visone, rosso veneziano, bianco caldo**  
nobilitato visone (opz.948M) schiena e ripiano visone (opz.948M)

**ANTE: grigio reale, grigio piombo, grigio singapore, blu fumo**  
nobilitato lavagna (opz.9620) schiena e ripiano lavagna (opz.9620)

**ANTE: verde felce, argilla, grigio alaska, grigio ombra**  
nobilitato argilla (opz.9690) schiena e ripiano argilla (opz.9690)



## MENSOLE

vedi pag.62-63

## ZOCCOLI

vedi pag.64

I PRODOTTI IN LEGNO SONO CONFORMI AL REGOLAMENTO (US EPA TSCA Title VI) RIGUARDO ALL'EMISSIONE DI FORMALDEIDE



## TECHNICAL FEATURES

---

### DOORS AND DRAWER FRONTS

22 mm thick door made of a wood particle board panel (compliant with US EPA TSCA Title VI) 19mm thick coated: on the exterior in acrylic 1.4 mm thick with matt finish (5 gloss), on the interior with matt krystal 1.2 mm thick matching the exterior, edging on the 4 sides, matt ABS edges 1 mm thick, available in the following colours:

absolute white (opt.7495), warm white (opt.7497), light dove grey (opt.896A), mink (opt.946A), alaska grey (opt.9581), royal grey (opt.9565), singapore grey (opt.9575), fern green (opt.8457), venetian red (opt.8147), clay (opt.9573), lead grey (opt.9569), shadow grey (opt.9585), smoke blue (opt.8353)

22 mm thick door made of a wood particle board panel (compliant with US EPA TSCA Title VI) 19mm thick coated: on the exterior in acrylic 1.4 mm thick with gloss finish (90 gloss), on the interior with gloss krystal 1.2 mm thick matching the exterior, edging on the 4 sides, gloss ABS edges 1 mm thick, available in the following colours:

absolute white (opt.7496), warm white (opt.7498), light dove grey (opt.895A), mink (opt.947A), alaska grey (opt.9582), royal grey (opt.9566), singapore grey (opt.9576), fern green (opt.8458), clay (opt.9574), lead grey (opt.9570), shadow grey (opt.9586), smoke blue (opt.8354)

---

### PROFILES AND FINGER RAILS LUX VERSION

**standard:** brill curved profile (opt.PC412), for flat finger rail brill (opt.412P)  
**on request:** curved profile for "L" shaped finger rail



**on request:** L shaped profile for flat finger rail  
L shaped profile for "L" shaped finger rail



**on request:** inclined profile for flat finger rail  
inclined profile "L" shaped finger rail



### PROFILE AND FINGER RAIL NECK VERSION

square door without profile with "L" shaped finger rail



**NOTE:** for the profile and finger rail finishes see page 39

---

### HANDLES

see page 48-61



## TECHNICAL FEATURES

---

### CARCASSES

**DOOR: absolute white**  
white chipboard (opt.001), white back panel and shelf (opt.001)

**DOOR: light dove grey**  
melamine-coated shell (opt.8910) back panel and shelf shell (opt.8910)

**DOORS: mink, venetian red, warm white**  
mink chipboard (opt.948M), mink back panel and shelf (opt.948M)

**DOORS: royal grey, lead grey, singapore grey, smoke blue**  
slateboard grey chipboard (opt.9620), slateboard grey back panel and shelf (opt.9620)

**DOORS: fern green, clay, alaska grey, shadow grey**  
melamine-coated clay (opt.9690) clay back panel and shelf (opt.9690)

---

### SHELVES

see page 62-63

---

### PLINTHS

see page 64

WOODEN PRODUCTS ARE COMPLIANT WITH REGULATIONS (US EPA TSCA Title VI) GOVERNING FORMALDEHYDE EMISSIONS



# Acrilico-Acrylic

SP. 22 MM TH. 22 MM

ante acrilico opaco  
matt acrylic doors

Lux  
Neck  
Bridge  
Head



anta grigio singapore (opz.9575)  
singapore grey door (opt.9575)

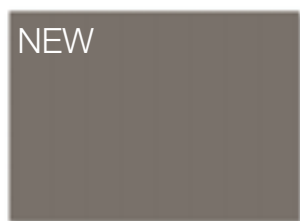

cestone grigio singapore  
(opz.9575)  
singapore grey deep drawer  
(opt.9575)



cassetto grigio singapore  
(opz.9575)  
singapore grey drawer  
(opt.9575)

## COLORI OPACHI MATT COLOURS

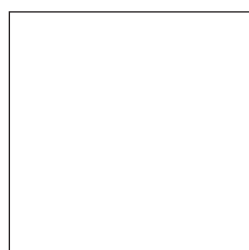

bianco assoluto (opz.7495)  
absolute white

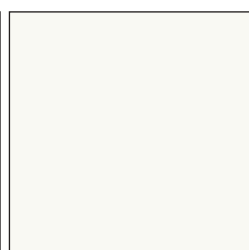

bianco caldo (opz.7497)  
warm white

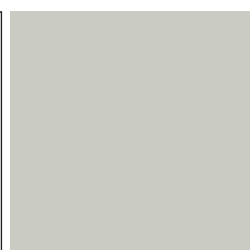

tortora chiaro (opz.896A)  
light dove grey

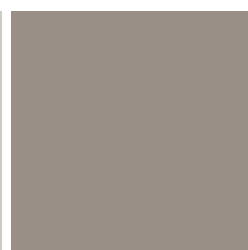

visone (opz.946A)  
mink



rosso veneziano  
(opz.8147)  
venetian red



grigio reale (opz.9565)  
royal grey



grigio singapore (opz.9575)  
singapore grey



verde felce (opz.8457)  
fern green

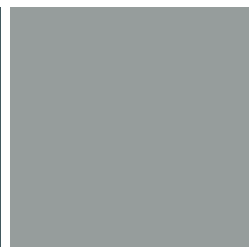

argilla (opz.9573)  
clay



grigio piombo (opz.9569)  
lead grey

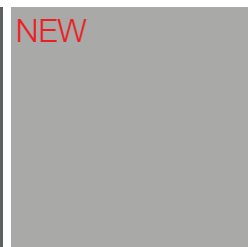

grigio alaska (opz.9581)  
alaska grey

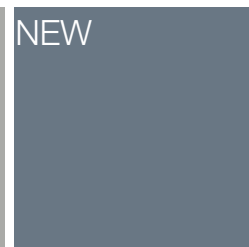

blu fumo (opz.8353)  
smoke blue

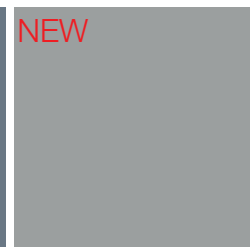

grigio ombra (opz.9585)  
shadow grey

# Acrilico-Acrylic

SP. 22 MM TH. 22 MM

ante acrilico lucido  
glossy acrylic doors

Lux  
Neck  
Bridge  
Head



NEW

anta grigio singapore (opz.9576)  
singapore grey door (opt.9576)



NEW

cestone grigio singapore  
(opz.9576)  
singapore grey deep drawer  
(opt.9576)

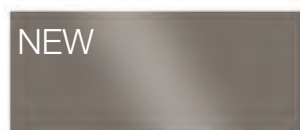

NEW

cassetto grigio singapore  
(opz.9576)  
singapore grey drawer  
(opt.9576)

## COLORI LUCIDI GLOSSY COLOURS

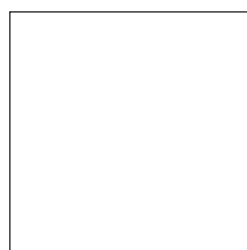

bianco assoluto (opz.7496)  
absolute white



bianco caldo (opz.7498)  
warm white

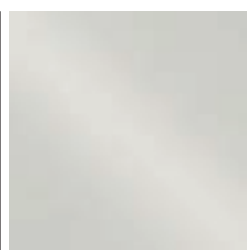

tortora chiaro (opz.895A)  
light dove grey

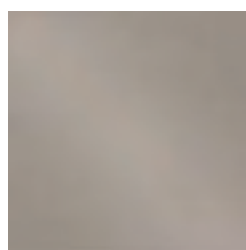

visone (opz.947A)  
mink

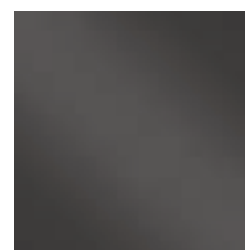

grigio reale (opz.9566)  
royal grey

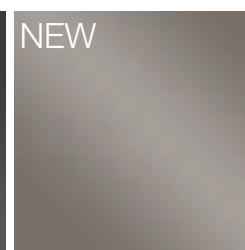

NEW

grigio singapore (opz.9576)  
singapore grey

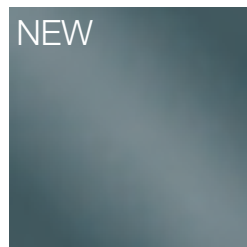

NEW

verde felce (opz.8458)  
fern green



argilla (opz.9574)  
clay

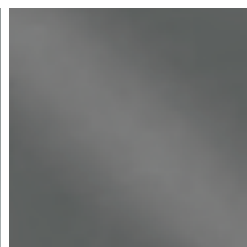

grigio piombo (opz.9570)  
lead grey

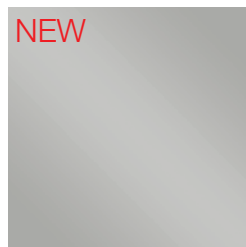

NEW

grigio alaska (opz.9582)  
alaska grey

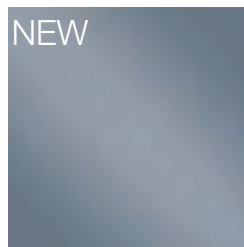

NEW

blu fumo (opz.8354)  
smoke blue

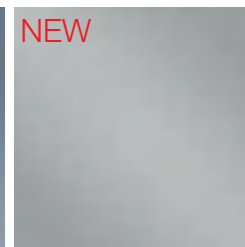

NEW

grigio ombra (opz.9586)  
shadow grey

## CARATTERISTICHE TECNICHE

### ANTE E FRONTALI CASSETTI

anta sp.22 costituita da un pannello in MDF sp.16 mm (conforme US EPA TSCA Title VI) rivestito:  
 nella parte esterna in acrilico glaks opaco sp.3 mm,  
 nella parte interna con metacrilato opaco (PMMA) sp.3 mm in tinta con l'esterno,  
 bordata sui 4 lati con bordo in ABS opaco sp.1 mm in tinta con bisellatura effetto vetro, nei colori opachi:  
 bianco assoluto (opz.7491), bianco caldo (opz.7493), tortora chiaro (opz.896G), visone (opz.946G), grigio alaska (opz.9583),  
 fango (opz.8883), grigio reale (opz.9563), grigio singapore (opz.9577), argilla (opz.9571), grigio piombo (opz.9567)  
 grigio ombra (opz.9587), blu fumo (opz.8355)

anta sp.22 costituita da un pannello in MDF sp.16 mm (conforme US EPA TSCA Title VI) rivestito:  
 nella parte esterna glaks in acrilico lucido sp.2 mm,  
 nella parte interna con metacrilato opaco (PMMA) sp.2 mm in tinta con l'esterno,  
 bordata sui 4 lati con bordo in ABS lucido sp.1 mm in tinta con bisellatura effetto vetro, nei colori lucidi:  
 bianco assoluto (opz.7492), bianco caldo (opz.7494), tortora chiaro (opz.895G), visone (opz.947G), grigio alaska (opz.9584),  
 fango (opz.8884), grigio reale (opz.9564), grigio singapore (opz.9578), argilla (opz.9572), grigio piombo (opz.9568)  
 grigio ombra (opz.9588), blu fumo (opz.8356)

**proprietà tecniche:** l'anta glaks opaca e lucida è resistente alla macchia, al graffio, anti-ingiallente ed il colore non vira nel tempo

### PROFILI E GOLE VERSIONE LUX

di serie: profilo curvo brill (opz.PC412), per gola piatta brill (opz.412P)  
 a richiesta: profilo curvo per gola ad "ELLE"



a richiesta: profilo ad elle per gola piatta  
 profilo ad elle per gola ad "ELLE"



a richiesta: profilo inclinato per gola piatta  
 profilo inclinato per gola "ELLE"



### PROFILO E GOLA VERSIONE NECK

anta squadrata senza profilo con gola "ELLE"



**N.B.:** per le finiture profili e gole vedi pag.39

### MANIGLIE

vedi pag.48-61

# CARATTERISTICHE TECNICHE

## STRUTTURE

**ANTE: bianco assoluto, grigio piombo**  
nobilitato bianco (opz.001) schiena e ripiano bianco (opz.001)

**ANTA: tortora chiaro**  
nobilitato conchiglia (opz.8910) schiena e ripiano conchiglia (opz.8910)

**ANTE: visone, bianco caldo**  
nobilitato visone (opz.948M) schiena e ripiano visone (opz.948M)

**ANTA: fango**  
nobilitato fango (opz.8860) schiena e ripiano fango (opz.8860)

**ANTE: grigio reale, grigio singapore, blu fumo**  
nobilitato lavagna (opz.9620) schiena e ripiano lavagna (opz.9620)

**ANTE: grigio alaska, grigio ombra, argilla,**  
nobilitato argilla (opz.9690) schiena e ripiano argilla (opz.9690)



## MENSOLE

vedi pag.62-63

## ZOCCOLI

vedi pag.64

I PRODOTTI IN LEGNO SONO CONFORMI AL REGOLAMENTO (US EPA TSCA Title VI) RIGUARDO ALL'EMISSIONE DI FORMALDEIDE





TH. 22 MM

## TECHNICAL FEATURES

### DOORS AND DRAWER FRONTS

22 mm thick door made of an MDF panel (compliant with US EPA TSCA Title VI) 16mm thick coated: on the exterior in glaks matt acrylic 3 mm thick, on the interior with matt methacrylate (PMMA) 3 mm thick, matching the exterior, edging on the 4 sides, matt ABS edges 1 mm thick, matching with glass-effect chamfering, in the following matt colours: absolute white (opt.7491), warm white (opt.7493), light dove grey (opt.896G), mink (opt.946G), alaska grey (opt.9583), mud (opt.8883), royal grey (opt.9563), singapore grey (opt.9577), clay (opt.9571), lead grey (opt.9567) shadow grey (opt.9587), smoke blue (opt.8355)

22 mm thick door made of an MDF panel (compliant with US EPA TSCA Title VI) 16mm thick coated: on the exterior in glaks gloss acrylic 2 mm thick, on the interior with matt methacrylate (PMMA) 2 mm thick, matching the exterior, edging on the 4 sides, matt ABS edges 1 mm thick, matching with glass-effect chamfering, in the following gloss colours: absolute white (opt.7492), warm white (opt.7494), light dove grey (opt.895G), mink (opt.947G), alaska grey (opt.9584), mud (opt.8884), royal grey (opt.9564), singapore grey (opt.9578), clay (opt.9572), lead grey (opt.9568) shadow grey (opt.9588), smoke blue (opt.8356)

**technical properties:** glaks doors in matt and gloss finishes are resistant to stains, scratches and yellowing. The colour will not change over time

### PROFILES AND FINGER RAILS LUX VERSION

**standard:** brill curved profile (opt.PC412), for flat finger rail brill (opt.412P)  
**on request:** curved profile for "L" shaped finger rail



**on request:** L shaped profile for flat finger rail  
L shaped profile for "L" shaped finger rail



**on request:** inclined profile for flat finger rail  
inclined profile "L" shaped finger rail



### PROFILE AND FINGER RAIL NECK VERSION

square door without profile with "L" shaped finger rail



**NOTE:** for the profile and finger rail finishes see page 39

### HANDLES

see page 48-61

## TECHNICAL FEATURES

---

### CARCASSES

**DOORS: absolute white, lead grey**  
white chipboard (opt.001), white back panel and shelf (opt.001)

**DOOR: light dove grey**  
melamine-coated shell (opt.8910) back panel and shelf shell (opt.8910)

**DOORS: mink, warm white**  
mink chipboard (opt.948M), mink back panel and shelf (opt.948M)

**DOOR: mud**  
mud chipboard (opt.8860), mud back panel and shelf (opt.8860)

**DOORS: royal grey, singapore grey, smoke blue**  
slateboard grey chipboard (opt.9620), slateboard grey back panel and shelf (opt.9620)

**DOORS: alaska grey, shadow grey, clay**  
melamine-coated clay (opt.9690) clay back panel and shelf (opt.9690)

---

### SHELVES

see page 62-63

---

### PLINTHS

see page 64

WOODEN PRODUCTS ARE COMPLIANT WITH REGULATIONS (US EPA TSCA Title VI) GOVERNING FORMALDEHYDE EMISSIONS



# Glaks

SP. 22 MM TH. 22 MM

ante in acrilico effetto vetro  
glass effect acrylic doors

Lux  
Neck  
Bridge  
Head



NEW

anta grigio singapore (opz.9577)  
singapore grey door (opt.9577)

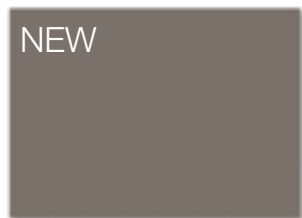

NEW

cestone grigio singapore  
(opz.9577)  
singapore grey deep drawer  
(opt.9577)

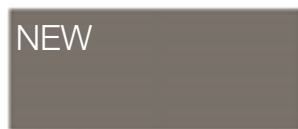

NEW

cassetto grigio singapore  
(opz.9577)  
singapore grey drawer  
(opt.9577)

## COLORI OPACHI MATT COLOURS

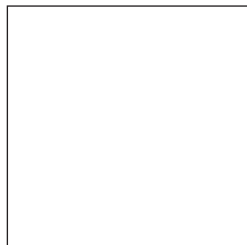

bianco assoluto (opz.7491)  
absolute white

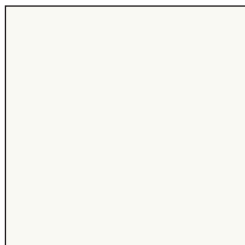

bianco caldo (opz.7493)  
warm white

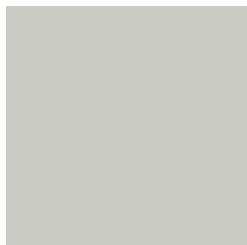

tortora chiaro (opz.896G)  
light dove grey

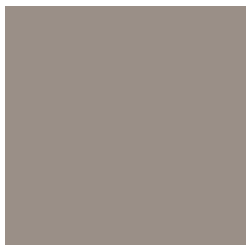

visone (opz.946G)  
mink

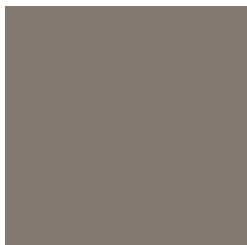

fango (opz.8883)  
mud

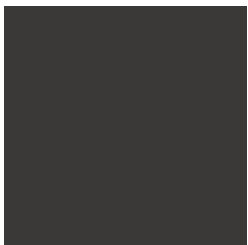

grigio reale (opz.9563)  
royal grey

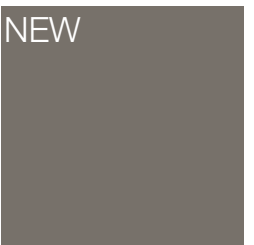

NEW

grigio singapore (opz.9577)  
singapore grey



argilla (opz.9571)  
clay



grigio piombo (opz.9567)  
lead grey



NEW

grigio alaska (opz.9583)  
alaska grey

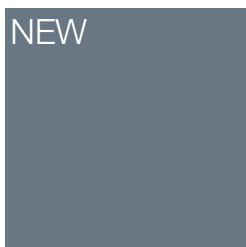

NEW

blu fumo (opz.8355)  
smoke blue



NEW

grigio ombra (opz.9587)  
shadow grey

## COLORI LUCIDI GLOSSY COLOURS



bianco assoluto (opz.7492)  
absolute white



bianco caldo (opz.7494)  
warm white



tortora chiaro (opz.895G)  
light dove grey



visone (opz.947G)  
mink

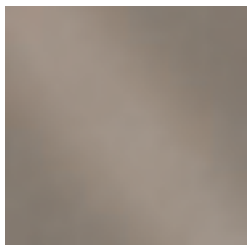

fango (opz.8884)  
mud

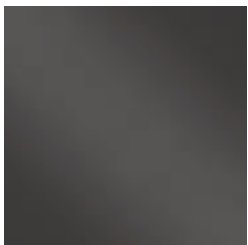

grigio reale (opz.9564)  
royal grey

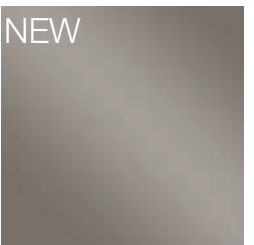

NEW

grigio singapore (opz.9578)  
singapore grey



argilla (opz.9572)  
clay

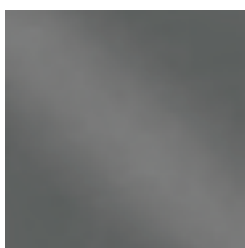

grigio piombo (opz.9568)  
lead grey



NEW

grigio alaska (opz.9584)  
alaska grey

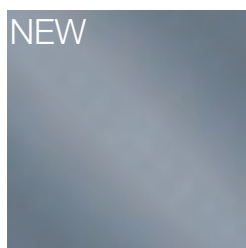

NEW

blu fumo (opz.8356)  
smoke blue

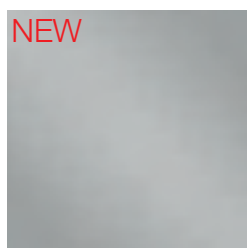

NEW

grigio ombra (opz.9588)  
shadow grey



## Telaio alluminio

Aluminium frame

---

**di serie:** telaio alluminio titanio sp.22 mm vetro satinato, bronzo o fumè

**standard:** 22 mm th. titanium aluminium frame satin, bronze or fumè glass



telaio titanio con vetro satinato  
(opt.TISAT)  
titanium frame with satin glass  
(opt.TISAT)



telaio titanio con vetro bronzo  
(opt.TIBRZ)  
titanium frame with bronze glass  
(opt.TIBRZ)



telaio titanio con vetro fumè  
(opt.TIFUM)  
titanium frame with fumè glass  
(opt.TIFUM)

**a richiesta :** telaio alluminio verniciato urban sp.22 mm vetro satinato, bronzo o fumè

**on request:** 22 mm th. urban painted aluminium frame satin, bronze or fumè glass



telaio urban con vetro satinato  
(opt.GISAT)  
urban frame with satin glass  
(opt.GISAT)



telaio urban con vetro bronzo  
(opt.GIBRZ)  
urban frame with bronze glass  
(opt.GIBRZ)



telaio urban con vetro fumè  
(opt.GIFUM)  
urban frame with fumè glass  
(opt.GIFUM)



# Vetro Glass

## Telaio alluminio

Aluminium frame

**a richiesta** : telaio alluminio verniciato silver dark sp.22 mm vetro satinato, bronzo o fumè  
**on request**: 22 mm th. silver dark painted aluminium frame satin, bronze or fumè glass



telaio silver dark con vetro satinato  
(opz.PISAT)  
silver dark frame with satin glass  
(opt.PISAT)



telaio silver dark con vetro bronzo  
(opz.PIBRZ)  
silver dark frame with bronze glass  
(opt.PIBRZ)



telaio silver dark con vetro fumè  
(opz.PIFUM)  
silver dark frame with fumè glass  
(opt.PIFUM)



particolare maniglia incassata  
sul traverso per ante con apertura  
a ribalta, pacchetto e verticale obliqua  
low frame build-in handle detail, for flap,  
lift-up folding and oblique vertical  
opening doors



particolare presa su interno  
montante per ante battenti  
internal grip handle detail,  
for hinged doors

SP. 22 MM TH. 22 MM

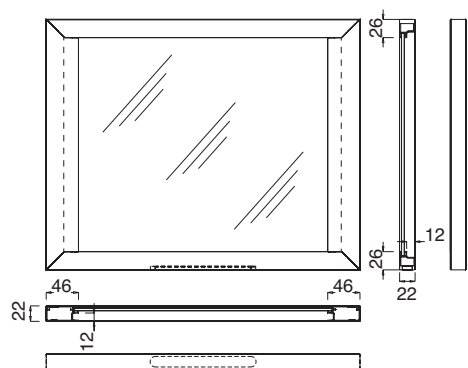

SP. 22 MM TH. 22 MM

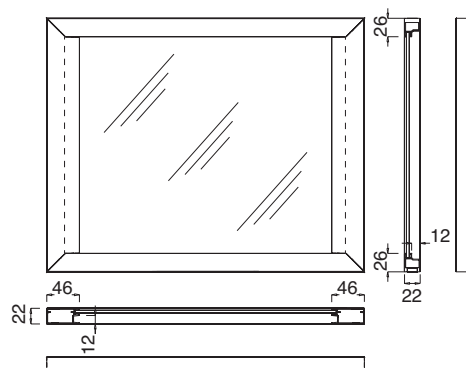

# APERTURA CON GOLA OPENING BY FINGER RAIL

LUX

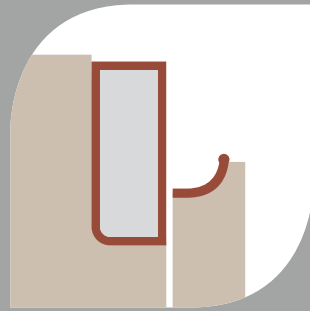
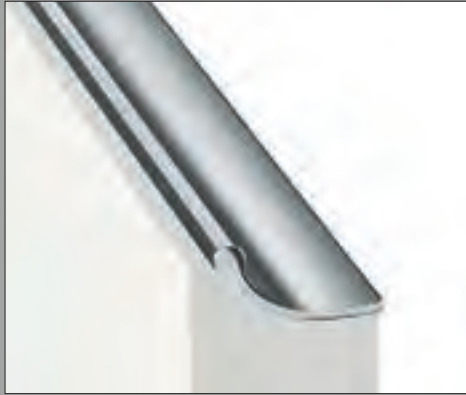

GOLA PIATTA  
FLAT FINGER RAIL



GOLA TIPO "ELLE"  
"ELLE" TYPE FINGER RAIL

## ANTA CON PROFILO CURVO

(OPZ. P C + COD. COLORE)  
DOOR WITH CURVED PROFILE

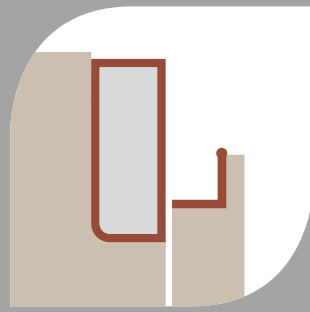

GOLA PIATTA  
FLAT FINGER RAIL

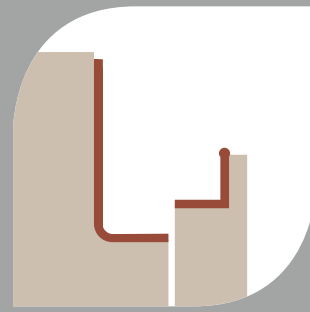

GOLA TIPO "ELLE"  
"ELLE" TYPE FINGER RAIL

## ANTA CON PROFILO AD "ELLE"

(OPZ. P L + COD. COLORE)  
DOOR WITH "ELLE" SHAPED PROFILE

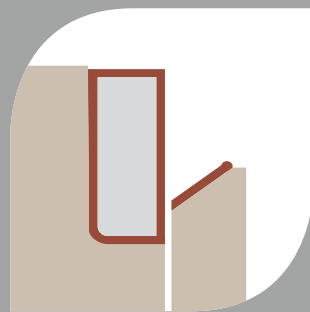

GOLA PIATTA  
FLAT FINGER RAIL



GOLA TIPO "ELLE"  
"ELLE" TYPE FINGER RAIL

## ANTA CON PROFILO INCLINATO

(OPZ. P I + COD. COLORE)  
DOOR WITH INCLINED PROFILE

Neck



GOLA TIPO "ELLE"  
"ELLE" TYPE FINGER RAIL

## ANTA **NECK** PER GOLA TIPO "ELLE"

"NECK" DOOR FOR "ELLE" TYPE  
FINGER RAIL



# FINITURE PROFILI E GOLE

## FINITURE PROFILI E GOLE SPAZZOLATI FINGER RAILS AND PROFILES BRUSHED FINISHES

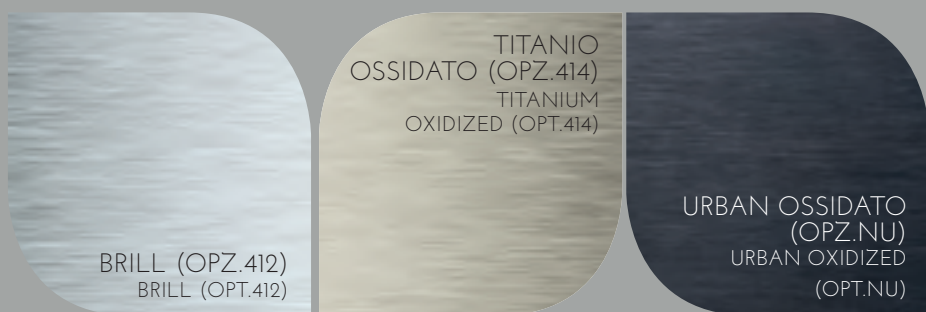



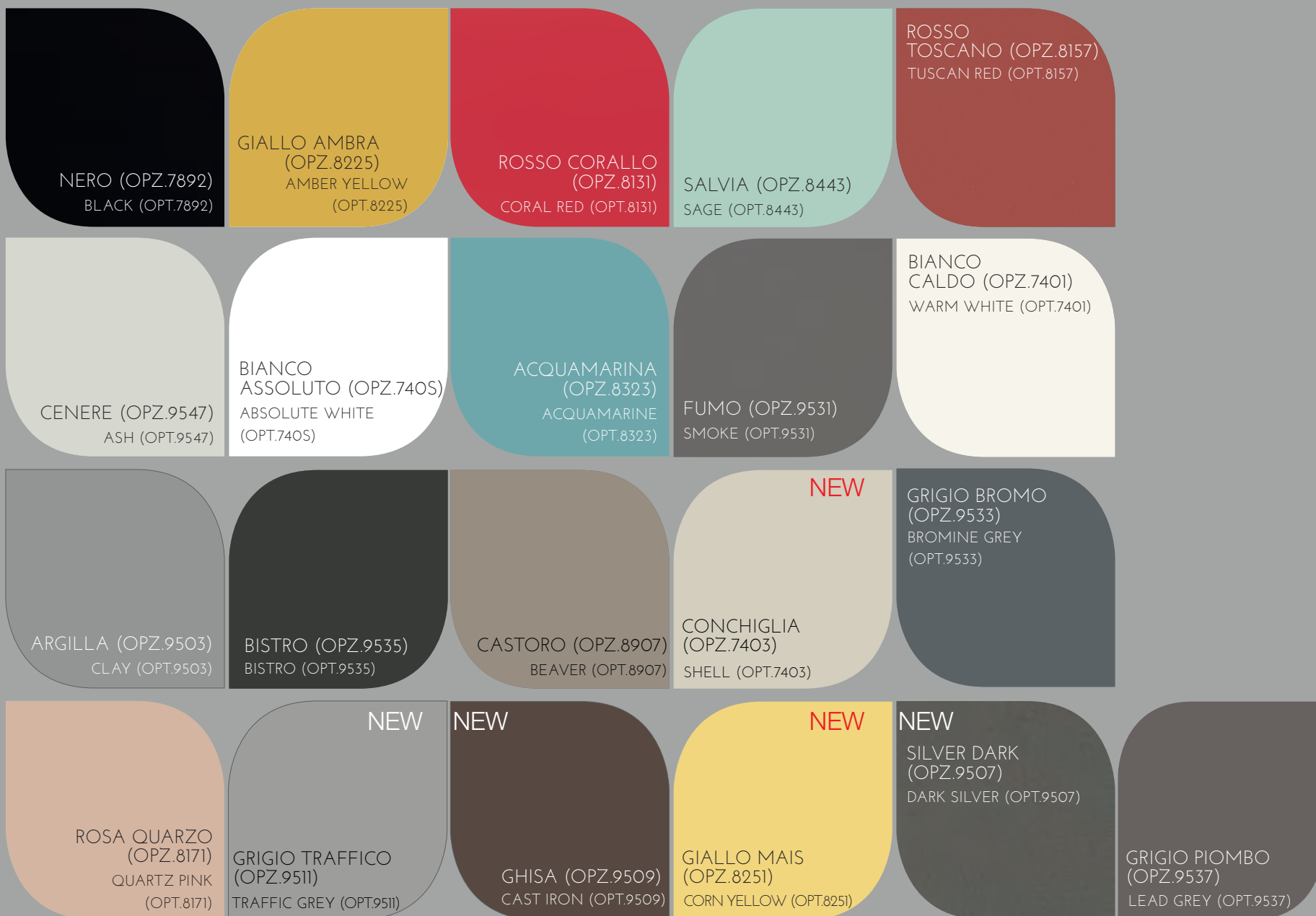

## FINITURE PROFILI E GOLE VERNICIATI A POLVERE OPACHI MATT FINGER RAILS AND PROFILES POWDER COATED FINISHES



# GOLA PIATTA ORIZZONTALE SOTTOTOP

UNDERMOUNT HORIZONTAL FLAT FINGER RAIL

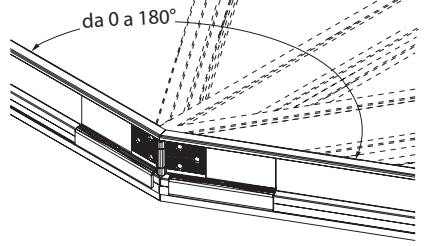



	COD.			COD.	
<p><b>Gola piatta sottotop tipo "AP"</b> Type "AP" undermount flat finger rail</p> 				<p><b>Angolo interno a 90° per gola tipo "AP"</b> 90° interior corner for "AP" type finger rail</p> 	
	al ml per lm	G960010		cadauno each	G960050
<p><b>Terminale chiuso "T1" dx o sx per gola tipo "AP" da utilizzare a fine composizione</b> "T1" RH or LH closure for type "AP" finger rail to be placed at the end of the composition</p> 				<p><b>Angolare con snodo per unione fuori squadra per gola tipo "AP"</b> Corner piece with joint for out-of-plumb joining for type "AP" finger rail</p> 	
	<b>terminale DX</b> RH end	G960021			
	<b>terminale SX</b> LH end	G960022			
<p><b>Terminale chiuso "T2" dx o sx per gola tipo "AP" da utilizzare solo tra basi e colonne</b> "T2" RH or LH closure for type "AP" finger rail to be placed only between base units and column</p> 					
	<b>terminale DX</b> RH end	G960031			
	<b>terminale SX</b> LH end	G960032			G950060

# GOLA PIATTA ORIZZONTALE INTERMEDIA

INTERMEDIATE HORIZONTAL **FLAT** FINGER RAIL

# GOLE VERTICALI PIATTE PER COLONNE

VERTICAL **FLAT** FINGER RAILS FOR COLUMNS

	COD.			
<p><b>Gola piatta intermedia tipo "BP"</b> Type "BP" intermediate flat finger rail</p> 			<p><b>Gola verticale piatta intermedia tipo "DP" (completa di distanziale)</b> Type "DP" intermediate vertical flat finger rail (complete with spacer)</p> 	
	<p>al ml per lm</p>	G960110		
<p><b>Terminale chiuso "T3" dx o sx per gola tipo "BP" da utilizzare a fine composizione</b> "T3" RH or LH closure for type "BP" finger rail to be placed at the end of the composition</p> 			<p><b>Gola verticale piatta laterale tipo "CP" (completa di distanziale)</b> Type "CP" vertical side flat finger rail (complete with spacer)</p> 	
	<p><b>terminale DX</b> RH end <b>terminale SX</b> LH end</p>	G960121 G960122		
<p><b>Terminale chiuso "T4" dx o sx per gola tipo "BP" da utilizzare solo tra cassettiere e lavastoviglie/colonne</b> "T4" RH or LH closure for type "BP" finger rail To be placed only between drawer units and dishwasher/columns</p> 			<p><b>N.B.: nuova tipologia di ferramenta/montaggio disponibile a partire da GENNAIO 2019</b> Note: new type of hardware for the assembly will be available starting from <b>JANUARY 2019</b></p>	
	<p><b>terminale DX</b> RH end <b>terminale SX</b> LH end</p>	G960131 G960132		



# NOZIONI UTILI - gole orizzontali **piatte** per basi

USEFUL INFORMATION - HORIZONTAL **FLAT** FINGER RAILS FOR BASE UNITS

## VISTA FRONTALE ZOCCOLO H 13 PER BASI H 88

FRONT VIEW PLINTH H 13 FOR BASE UNITS H 88

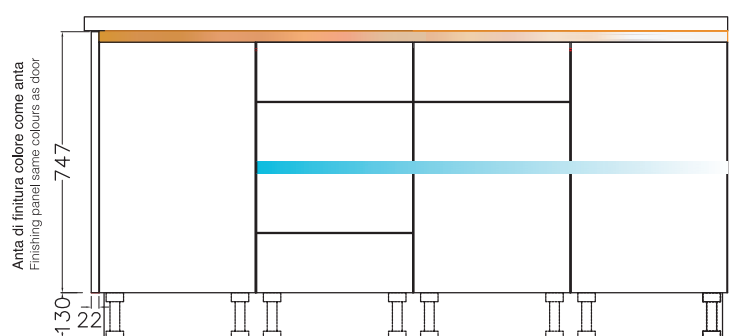
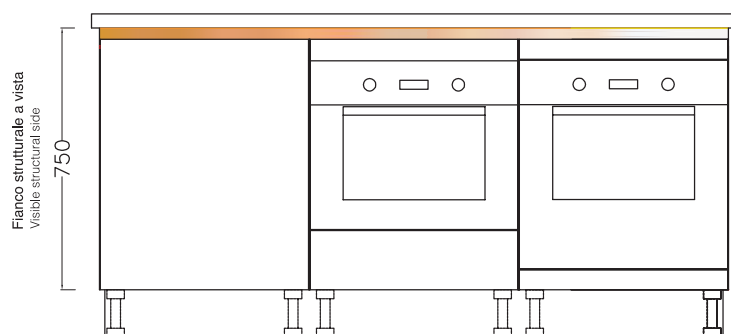

## VISTA FRONTALE ZOCCOLO H 6 PER BASI H 90

FRONT VIEW PLINTH H 6 FOR BASE UNITS H 90

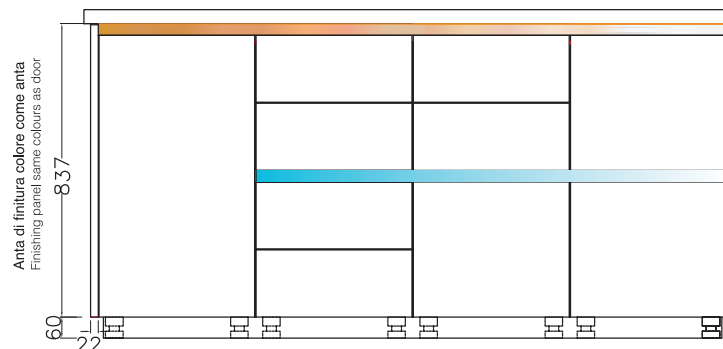
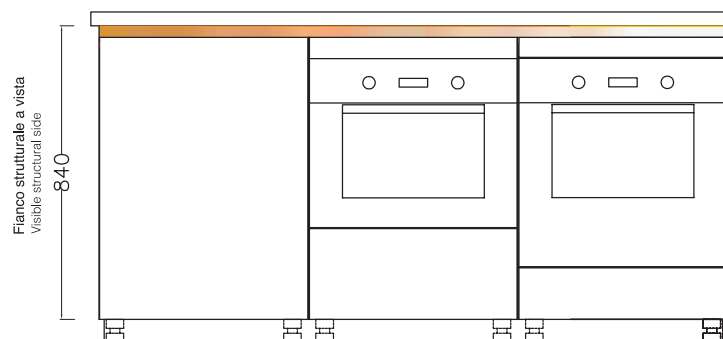

## VISTA LATERALE (sezione) ZOCCOLO H 13 PER BASI H 88

SIDE VIEW (CROSS SECTION) PLINTH H 13 FOR BASE UNITS H 88

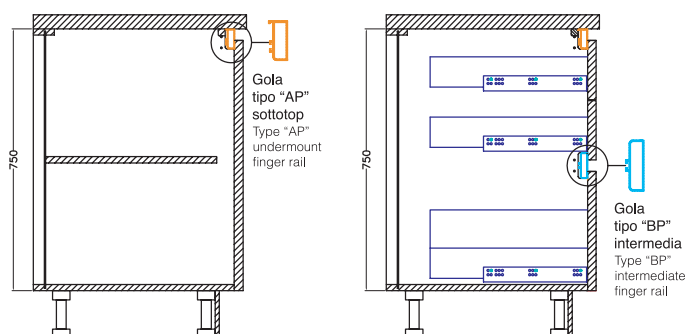

## VISTA LATERALE (sezione) ZOCCOLO H 6 PER BASI H 90

SIDE VIEW (CROSS SECTION) PLINTH H 6 FOR BASE UNITS H 90

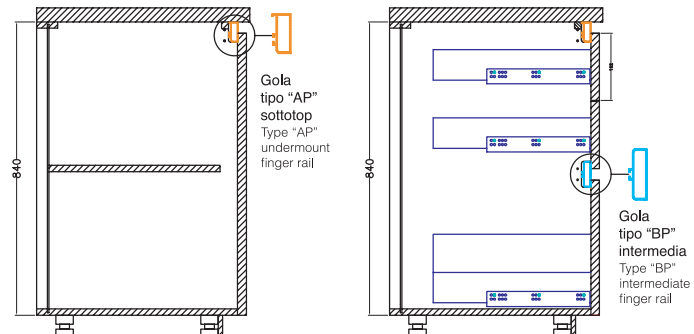

## VISTA DALL'ALTO

TOP VIEW

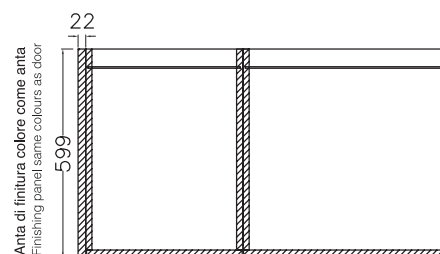
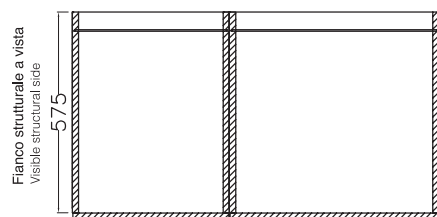

Composizione con ante di finitura laterali: alla dimensione finale della cucina, sommare sempre lo spessore delle ante di finitura (ogni anta 2,2 cm)

Composition with side finishing panels: to the final size of the kitchen, always add the thickness of the finishing panels (each panel 22 mm)

# NOZIONI UTILI - gole verticali **piatte** per colonne

USEFUL INFORMATION - VERTICAL **FLAT** FINGER RAILS FOR COLUMNS

## VISTA FRONTALE ZOCCOLO H 13

FRONT VIEW PLINTH H 13

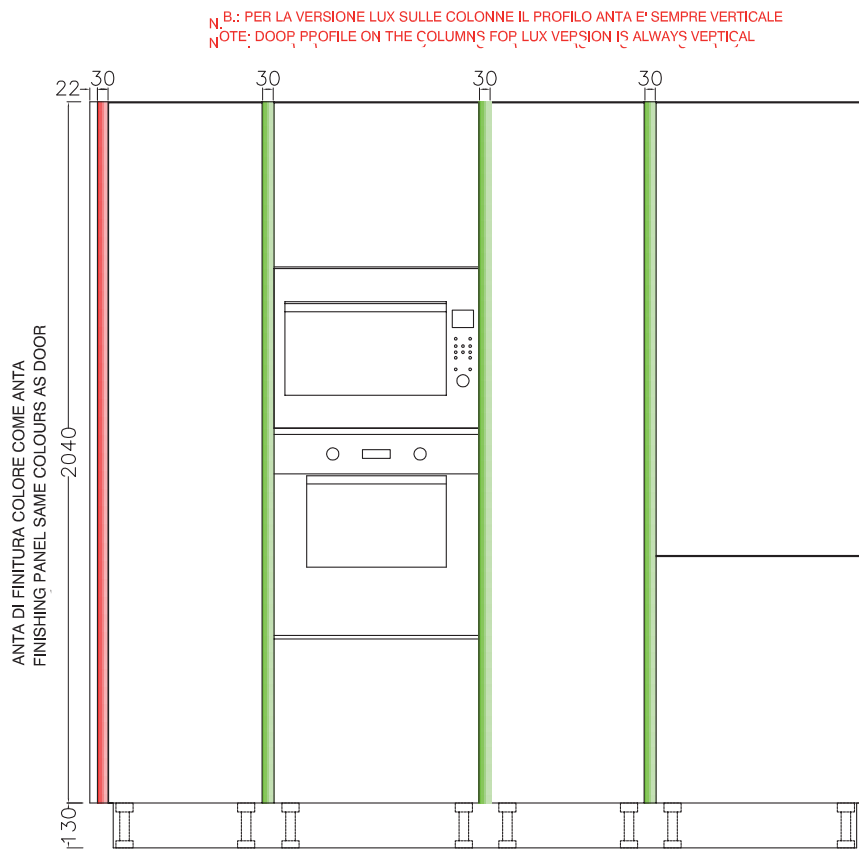

## VISTA FRONTALE ZOCCOLO H 6

FRONT VIEW PLINTH H 6

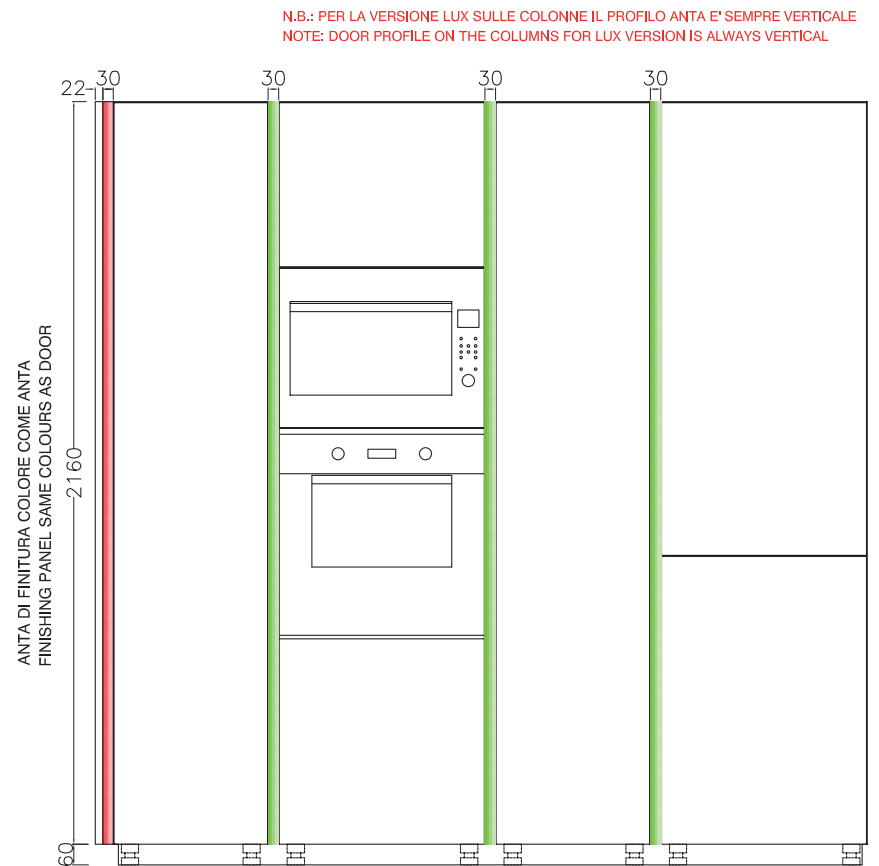

## VISTA DALL'ALTO

TOP VIEW

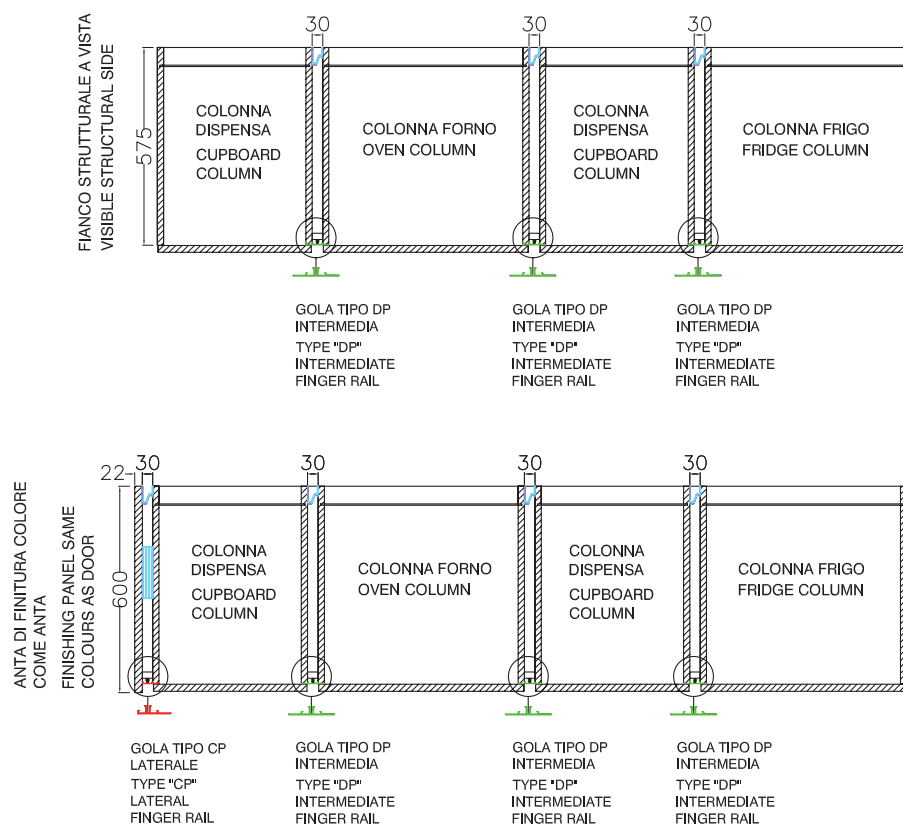

Composizione fianco strutturale  
a vista come anta:  
alla dimensione finale della cucina,  
sommare sempre lo spessore dei  
distanziali tra le colonne  
(ogni distanziale 3 cm)

Composition with visible side panel to match door:  
to the final size of the kitchen, always add the thickness  
of the spacers between the two columns (each spacer 3 cm)

Composizione con ante di finitura  
laterali, alla dimensione finale della  
cucina, sommare sempre lo spessore  
dei distanziali tra le colonne  
(ogni distanziale 3 cm) e lo spessore  
delle ante di finitura (ogni anta 2,2 cm)









Composition with side finishing panels to the final size of the  
kitchen, always add the thickness of the spacer between the  
two columns (each spacer 3 cm) and the thickness of the  
finishing panels (each panel 22 mm)

**N.B.: nuova tipologia di ferramenta/montaggio  
disponibile a partire da GENNAIO 2019**

Note: new type of hardware for the assembly will be  
available starting from JANUARY 2019

# GOLA "ELLE" ORIZZONTALE SOTTOTOP

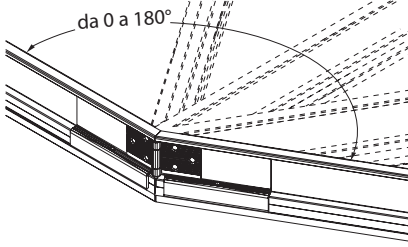
UNDERMOUNT HORIZONTAL "ELLE" FINGER RAIL



	COD.			COD.		
<p><b>Gola sottotop tipo "A"</b> Type "A" undermount finger rail</p>  <p style="text-align: right;"><b>al ml</b> per lm</p>	G950010			<p><b>Angolo interno a 90° per gola tipo "A"</b> 90° interior corner for "A" type finger rail</p>  <p style="text-align: right;"><b>cadauno</b> each</p>	G950050	
<p><b>Terminale aperto dx o sx per gola tipo "A" da utilizzare a fine composizione</b> RH or LH open end for type "A" finger rail to be placed at the end of the composition</p>  <p style="text-align: right;"><b>terminale DX</b> RH end</p>	G950021			<p><b>Angolare con snodo per unione fuori squadra per gola tipo "A"</b> Corner piece with joint for out-of-plumb joining for type "A" finger rail</p> 		
<p><b>terminale SX</b> LH end</p>	G950022					
<p><b>Terminale chiuso dx o sx per gola tipo "A" da utilizzare solo tra basi e colonne</b> RH or LH closure for type "A" finger rail to be placed only between base units and column</p>  <p style="text-align: right;"><b>terminale DX</b> RH end</p>	G950031					
<p><b>terminale SX</b> LH end</p>	G950032					
<p><b>Terminale chiuso dx o sx per gola tipo "A" da utilizzare solo tra basi e colonne</b> RH or LH closure for type "A" finger rail to be placed only between base units and column</p>  <p style="text-align: right;"><b>terminale DX</b> RH end</p>	G950031			 <p style="text-align: center;">da 0 a 180°</p>	G950060	
<p><b>terminale SX</b> LH end</p>	G950032					
<p><b>Coppia angolari per kit raccordo base angolo 110x110</b> Couple corner piece for fitting kit corner base unit 110x110</p>  <p style="text-align: center;">SX LH                      DX RH</p> <p style="text-align: right;"><b>in alluminio</b> aluminium</p>						
<p><b>angolare DX</b> RH corner piece</p>	G950058					
<p><b>angolare SX</b> LH corner piece</p>	G950059					



# GOLA "ELLE" ORIZZONTALE INTERMEDIA

INTERMEDIATE HORIZONTAL "ELLE" FINGER RAIL

# GOLE "ELLE" VERTICALI PER COLONNE

VERTICAL "ELLE" FINGER RAILS FOR COLUMNS

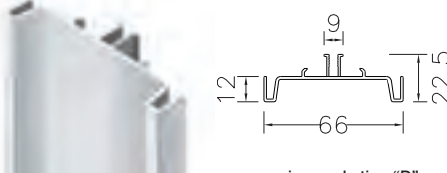
	COD.	
<p><b>Gola intermedia tipo "B"</b></p> <p>Type "B" intermediate finger rail</p> 		
<b>al ml per lm</b>	G950110	
<p><b>Terminale aperto dx o sx per gola tipo "B" da utilizzare a fine composizione</b></p> <p>RH or LH open end for type "B" finger rail to be placed at the end of the composition</p> 		
<b>terminale DX</b> RH end	G950121	
<b>terminale SX</b> LH end	G950122	
<p><b>Terminale chiuso dx o sx per gola tipo "B" da utilizzare solo tra cassettiere e lavastoviglie/colonne</b></p> <p>RH or LH closure for type "B" finger rail to be placed only between drawer units and dishwasher/columns</p> 		
<b>terminale DX</b> RH end	G950131	
<b>terminale SX</b> LH end	G950132	
<p><b>Angolo interno a 90° per gola tipo "B"</b></p> <p>90° interior corner for "B" type finger rail</p> 		
<b>cadauno</b> each	G950150	

	COD.	
<p><b>Mezza gola verticale tipo "C" (completa di distanziale)</b></p> <p>Type "C" half vertical finger rail (complete with spacer)</p>  <p><b>sezione mezza gola tipo "C"</b> cross section of type "C" finger rail</p>		
<b>Piedi H 13</b>	H 96	G950310
	H 132	G950330
	H 204	G950350
	H 228	G950370
<b>Piedi H 6</b>	H 108	G950320
	H 144	G950340
	H 216	G950360
<p><b>Gola verticale intermedia tipo "D" (completa di distanziale)</b></p> <p>Type "D" intermediate vertical finger rail (complete with spacer)</p>  <p><b>sezione gola tipo "D"</b> cross section of type "D" finger rail</p>		
<b>Piedi H 13</b>	H 96	G950410
	H 132	G950430
	H 204	G950450
	H 228	G950470
<b>Piedi H 6</b>	H 108	G950420
	H 144	G950440
	H 216	G950460
<p><b>Gola verticale laterale tipo "E" (completa di distanziale)</b></p> <p>Type "E" lateral vertical finger rail (complete with spacer)</p>  <p><b>sezione gola tipo "E"</b> cross section of type "E" finger rail</p>		
<b>Piedi H 13</b>	H 96	G950510
	H 132	G950530
	H 204	G950550
	H 228	G950570
<b>Piedi H 6</b>	H 108	G950520
	H 144	G950540
	H 216	G950560
<p><b>N.B.: nuova tipologia di ferramenta/montaggio disponibile a partire da GENNAIO 2019</b></p> <p>Note: new type of hardware for the assembly will be available starting from <b>JANUARY 2019</b></p>		

# NOZIONI UTILI - gole "elle" orizzontali per basi

USEFUL INFORMATION - HORIZONTAL "ELLE" FINGER RAILS FOR BASE UNITS

## VISTA FRONTALE ZOCCOLO H 13 PER BASI H 88

FRONT VIEW PLINTH H 13 FOR BASE UNITS H 88

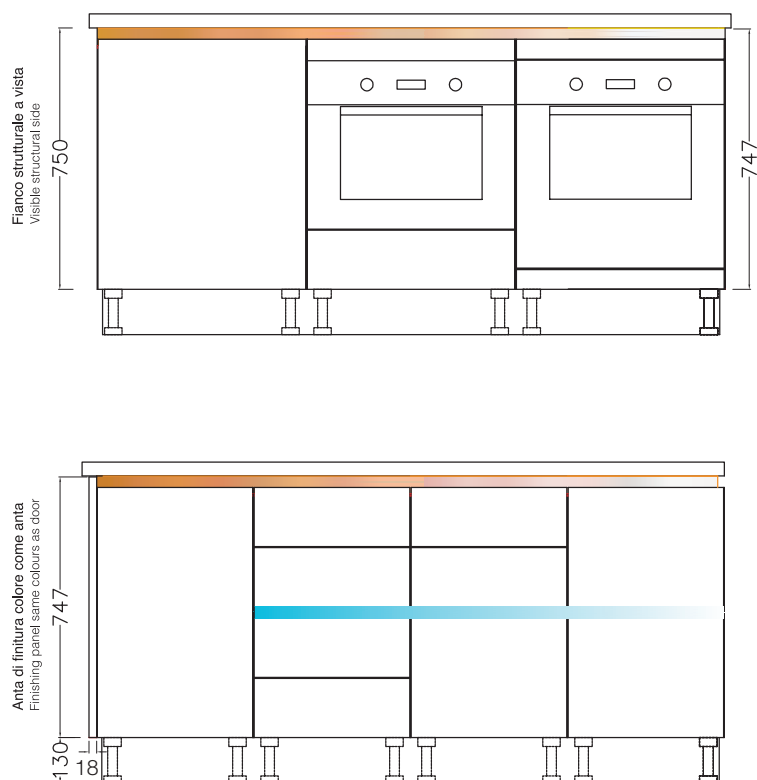

## VISTA FRONTALE ZOCCOLO H 6 PER BASI H 90

FRONT VIEW PLINTH H 6 FOR BASE UNITS H 90

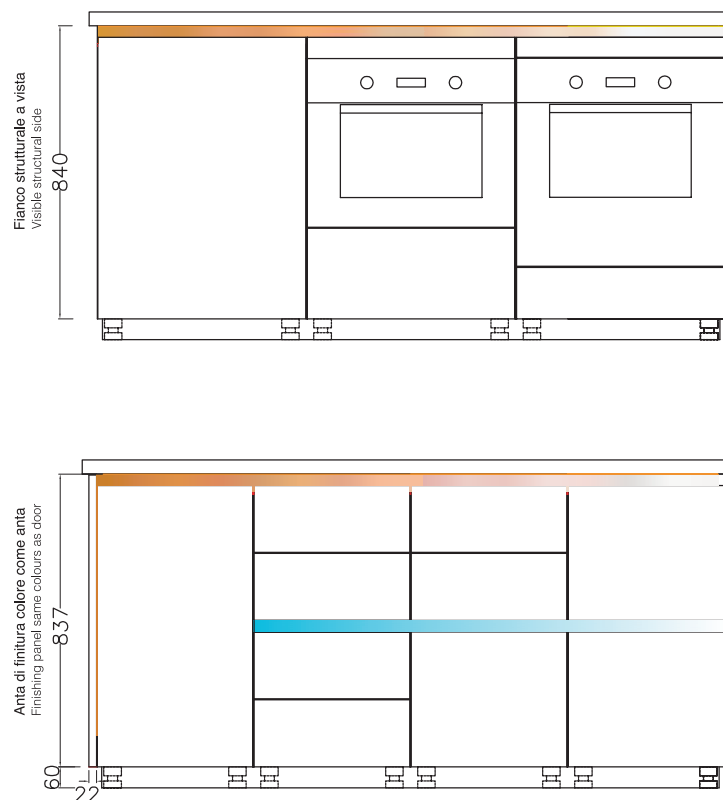

## VISTA LATERALE (sezione) ZOCCOLO H 13 PER BASI H 88

SIDE VIEW (CROSS SECTION) PLINTH H 13 FOR BASE UNITS H 88

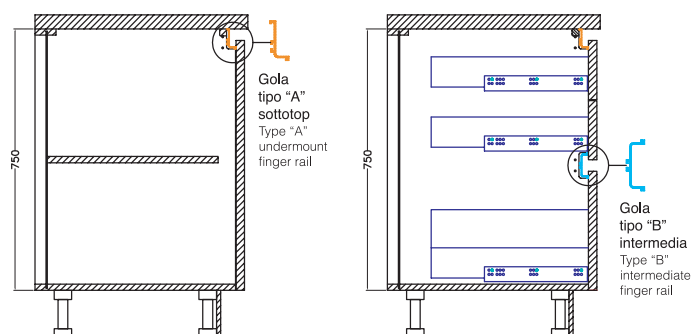

## VISTA LATERALE (sezione) ZOCCOLO H 6 PER BASI H 90

SIDE VIEW (CROSS SECTION) PLINTH H 6 FOR BASE UNITS H 90

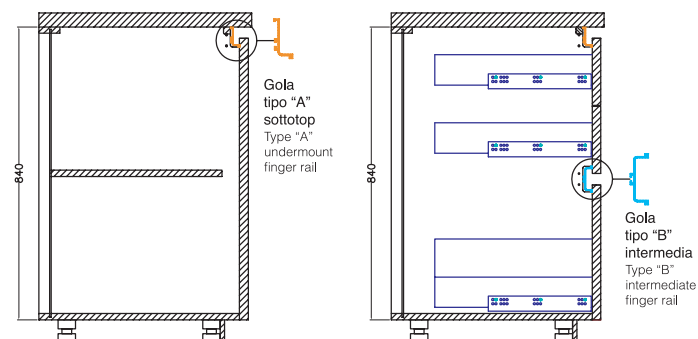

## VISTA DALL'ALTO

TOP VIEW

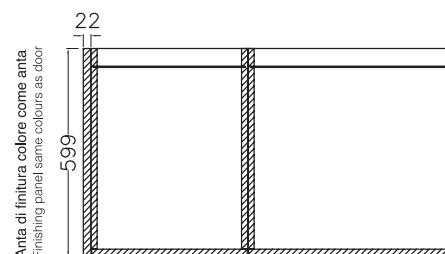
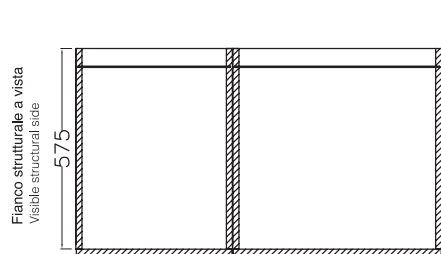

Composizione con ante di finitura laterali: alla dimensione finale della cucina, sommare sempre lo spessore delle ante di finitura (ogni anta 2,2 cm)

Composition with side finishing panels: to the final size of the kitchen, always add the thickness of the finishing panels (each panel 22 mm)



# NOZIONI UTILI - gole "elle" verticali per colonne

USEFUL INFORMATION - VERTICAL "ELLE" FINGER RAILS FOR COLUMNS

## VISTA FRONTALE ZOCCOLO H 13

FRONT VIEW PLINTH H 13

N.B.: PER LA VERSIONE LUX SULLE COLONNE IL PROFILO ANTA E' SEMPRE VERTICALE  
NOTE: DOOR PROFILE ON THE COLUMNS FOR LUX VERSION IS ALWAYS VERTICAL

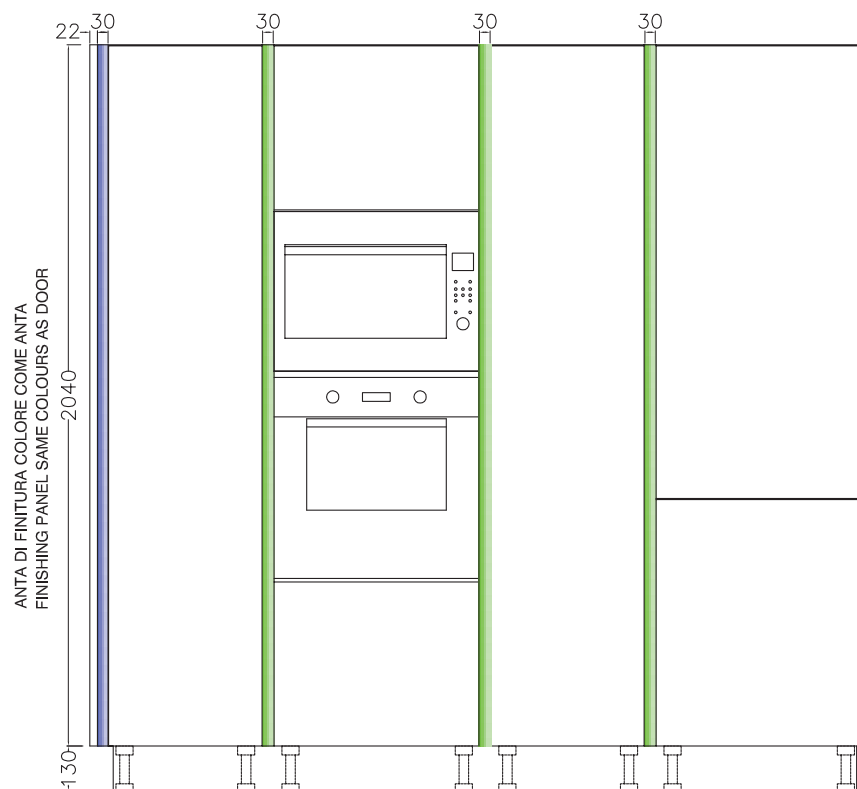

## VISTA FRONTALE ZOCCOLO H 6

FRONT VIEW PLINTH H 6

N.B.: PER LA VERSIONE LUX SULLE COLONNE IL PROFILO ANTA E' SEMPRE VERTICALE  
NOTE: DOOR PROFILE ON THE COLUMNS FOR LUX VERSION IS ALWAYS VERTICAL

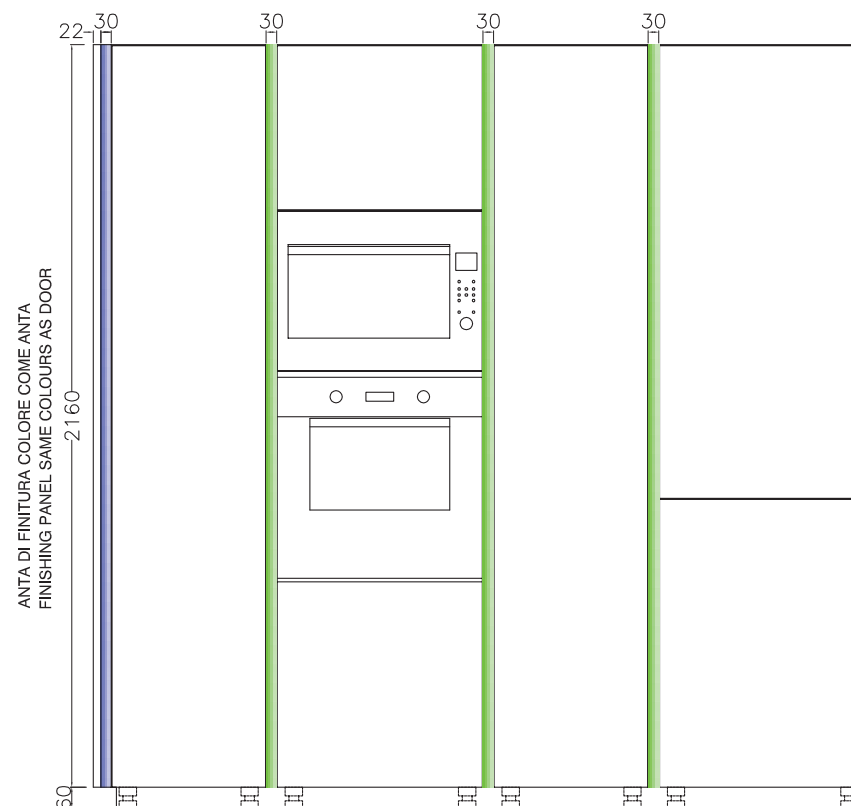

## VISTA DALL'ALTO

TOP VIEW

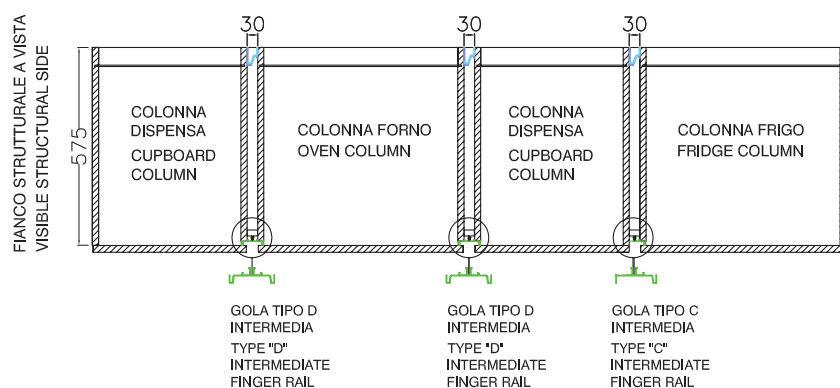

Composizione fianco strutturale a vista come anta: alla dimensione finale della cucina, sommare sempre lo spessore dei distanziali tra le colonne (ogni distanziale 3 cm)

Composition with visible side panel to match door: to the final size of the kitchen, always add the thickness of the spacers between the two columns (each spacer 3 cm)

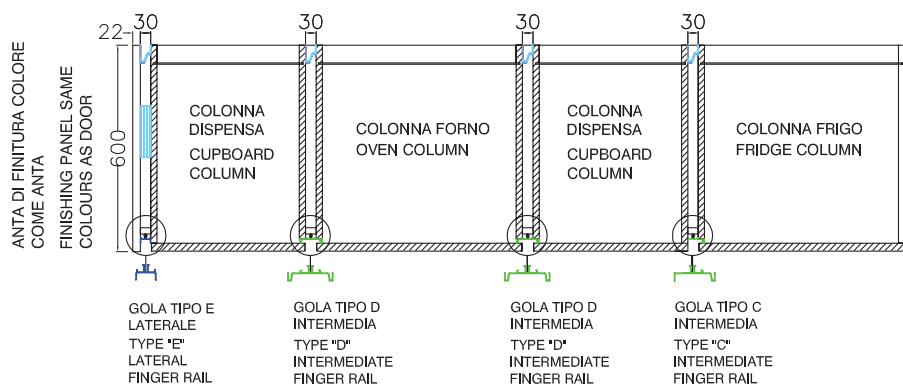

Composizione con ante di finitura laterali, alla dimensione finale della cucina, sommare sempre lo spessore dei distanziali tra le colonne (ogni distanziale 3 cm) e lo spessore delle ante di finitura (ogni anta 2,2 cm)

Composition with side finishing panels to the final size of the kitchen, always add the thickness of the spacer between the two columns (each spacer 3 cm) and the thickness of the finishing panels (each panel 22 mm)

**N.B.: nuova tipologia di ferramenta/montaggio disponibile a partire da GENNAIO 2019**

Note: new type of hardware for the assembly will be available starting from JANUARY 2019

## MANIGLIE HANDLES

**PLUS**  
immagina **Bridge**



Maniglia 475C finitura cromo  
anta L 15 → passo 96 mm  
anta da L 30 a L 45 → passo 160 mm  
anta da L 60 a L 120 → passo 320 mm

Handle 475C chrome finish  
door W 15 → centre-to-centre distance 96 mm  
door from W 30 to W 45 → centre-to-centre distance 160 mm  
door from W 60 to W 120 → centre-to-centre distance 320 mm



Maniglia 466 finitura cromo  
anta L 15 → passo 96 mm  
anta da L 30 a L 45 → passo 160 mm  
anta da L 60 a L 120 → passo 320 mm

Handle 466 chrome finish  
door W 15 → centre-to-centre distance 96 mm  
door from W 30 to W 45 → centre-to-centre distance 160 mm  
door from W 60 to W 120 → centre-to-centre distance 320 mm



Maniglia 477 finitura cromo  
anta L 15 → passo 64 mm  
anta da L 30 a L 45 → passo 160 mm  
anta da L 60 a L 120 → passo 320 mm

Handle 477 chrome finish  
door W 15 → centre-to-centre distance 64 mm  
door from W 30 to W 45 → centre-to-centre distance 160 mm  
door from W 60 to W 120 → centre-to-centre distance 320 mm



Maniglia 551 finitura cromo  
anta L 15 → passo 64 mm  
anta da L 30 a L 45 → passo 160 mm  
anta da L 60 a L 120 → passo 320 mm

Handle 551 chrome finish  
door W 15 → centre-to-centre distance 64 mm  
door from W 30 to W 45 → centre-to-centre distance 160 mm  
door from W 60 to W 120 → centre-to-centre distance 320 mm



Maniglia 554 finitura nichel satinato  
anta L 15 → passo 64 mm  
anta da L 30 a L 45 → passo 160 mm  
anta da L 60 a L 120 → passo 320 mm

Handle 554 satin nickel finish  
door W 15 → centre-to-centre distance 64 mm  
door from W 30 to W 45 → centre-to-centre distance 160 mm  
door from W 60 to W 120 → centre-to-centre distance 320 mm



Maniglia 569 finitura cromo  
anta L 15 → passo 64 mm  
anta da L 30 a L 45 → passo 160 mm  
anta da L 60 a L 120 → passo 320 mm

Handle 569 chrome finish  
door W 15 → centre-to-centre distance 64 mm  
door from W 30 to W 45 → centre-to-centre distance 160 mm  
door from W 60 to W 120 → centre-to-centre distance 320 mm



Maniglia 567 finitura nichel satinato  
anta L 15 → passo 64 mm  
anta da L 30 a L 45 → passo 160 mm  
anta da L 60 a L 120 → passo 320 mm

Handle 567 satin nickel finish  
door W 15 → centre-to-centre distance 64 mm  
door from W 30 to W 45 → centre-to-centre distance 160 mm  
door from W 60 to W 120 → centre-to-centre distance 320 mm

# MANIGLIE HANDLES

## MANIGLIE AD INCASSO RECESSED HANDLES



Maniglia 941C ad incasso finitura cromo  
dimensioni mm L 182 H 47

Handle 941C recessed chrome finish  
dimensions W 182 H 47 mm



Maniglia "Blend" ad incasso finitura titanio  
dimensioni mm L 63 H 105  
**N.B.: disponibile solo per le finiture melaminiche  
vedi pag. 14-17**

Handle "Blend" recessed titan finish  
dimensions W 63 H 105 mm  
**Note: available only for melamine finishes see page 14-17**



Maniglia 947S ad incasso finitura silver dark  
anta L 15 → dimensioni L 85  
anta da L 30 a L 45 → dimensioni L 190  
anta da L 60 a L 120 → dimensioni L 340  
anta da H 203,7 a H 215,7 → dimensioni L 676

Handle 947S recessed dark silver finish  
door W 15 → dimensions W 85  
door from W 30 to W 45 → dimensions W 190  
door from W 60 to W 120 → dimensions W 340  
door from H 203,7 to H 215,7 → dimensions W 676



Maniglia 947G ad incasso finitura verniciato ghisa  
anta L 15 → dimensioni L 85  
anta da L 30 a L 45 → dimensioni L 190  
anta da L 60 a L 120 → dimensioni L 340  
anta da H 203,7 a H 215,7 → dimensioni L 676

Handle 947G recessed cast iron painted finish  
door W 15 → dimensions W 85  
door from W 30 to W 45 → dimensions W 190  
door from W 60 to W 120 → dimensions W 340  
door from H 203,7 to H 215,7 → dimensions W 676



Maniglia 947T ad incasso finitura titanio  
anta L 15 → dimensioni L 85  
anta da L 30 a L 45 → dimensioni L 190  
anta da L 60 a L 120 → dimensioni L 340  
anta da H 203,7 a H 215,7 → dimensioni L 676

Handle 947T recessed titanium finish  
door W 15 → dimensions W 85  
door from W 30 to W 45 → dimensions W 190  
door from W 60 to W 120 → dimensions W 340  
door from H 203,7 to H 215,7 → dimensions W 676

Anta monoporta con maniglia in verticale  
Single-door with vertical handle

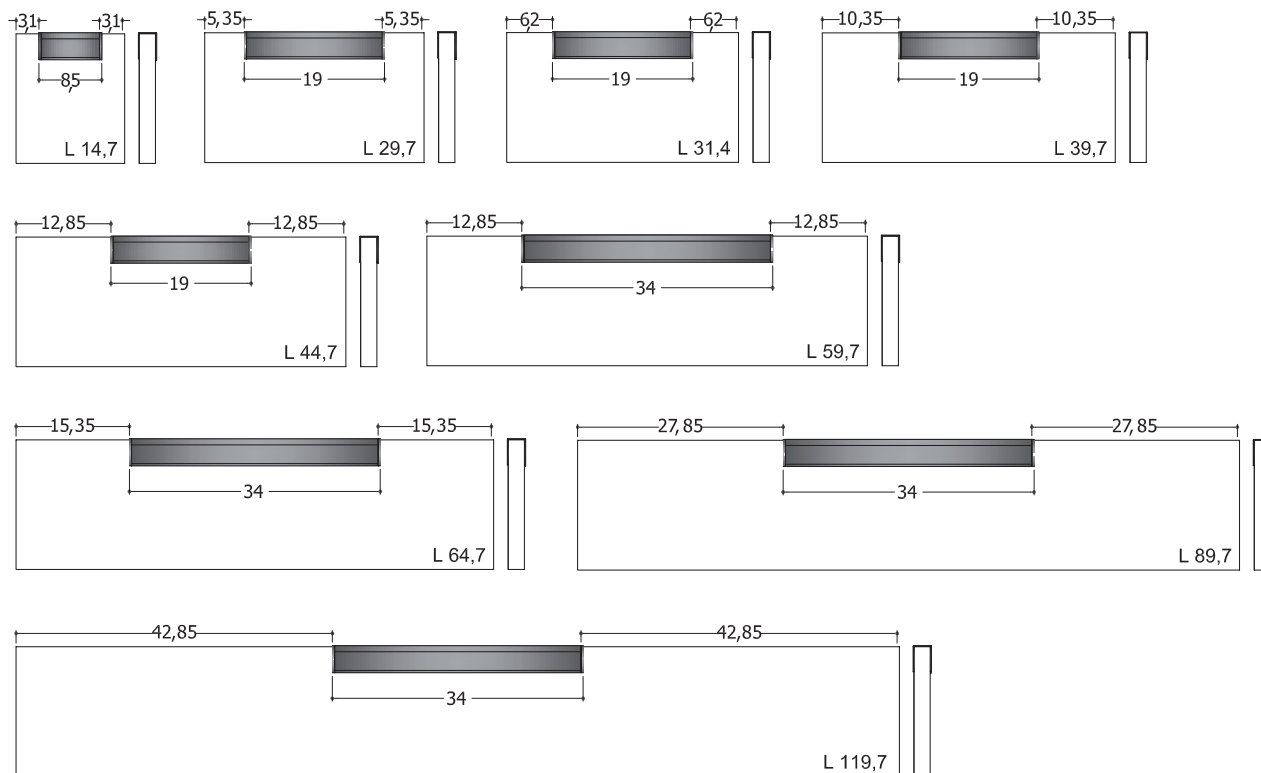
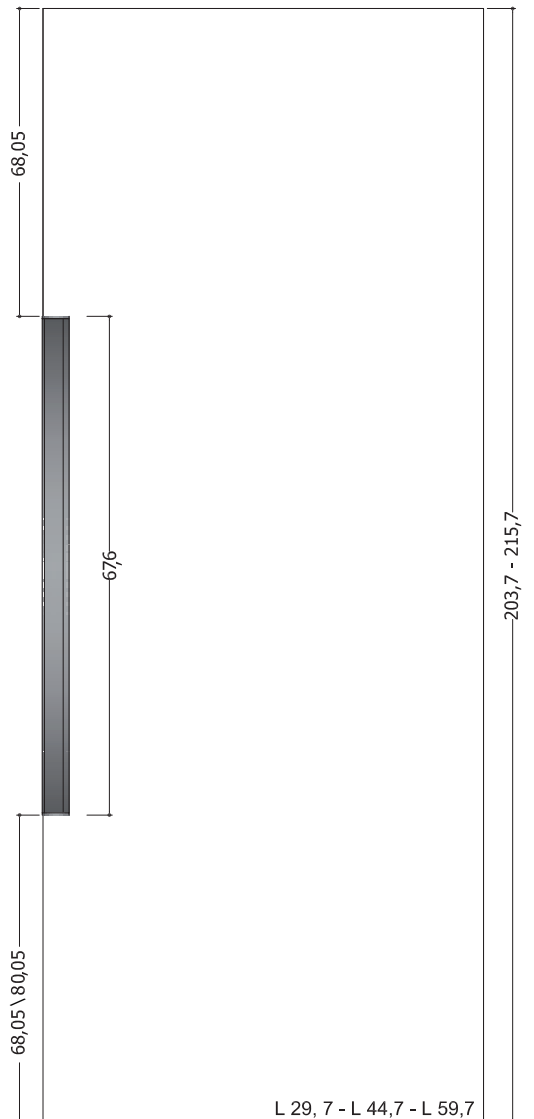

**MANIGLIA ORIZZONTALE** HANDLE HORIZONTAL

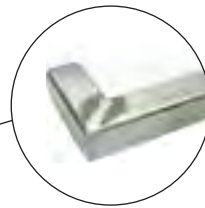

Maniglia con saldatura a vista negli angoli  
Handle with visible welding in the corners

Maniglia M41 finitura ferro grezzo  
passo in funzione dell'anta  
Handle M41 unrefined iron finish  
centre-to-centre distance varies according to the door

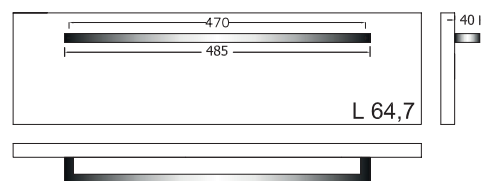
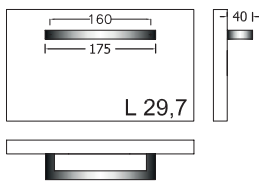
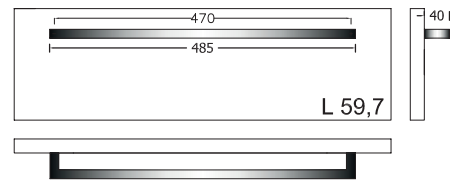
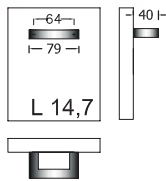

**ANGOLO PENSILE A LIBRO**  
corner wall unit folding

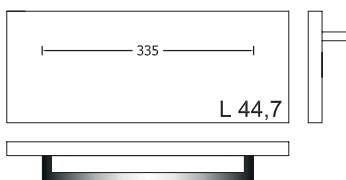
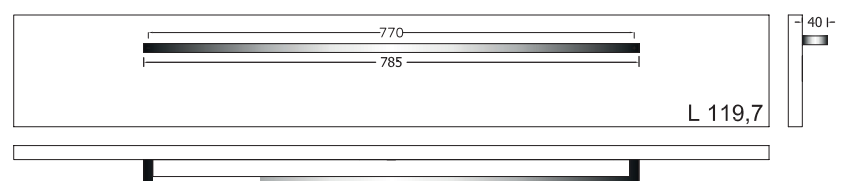
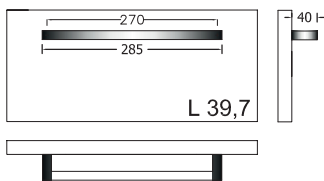
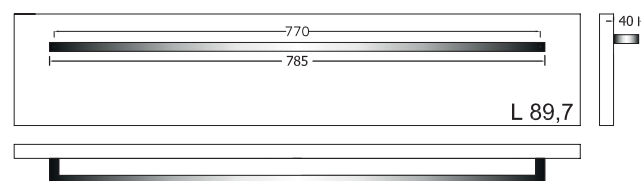
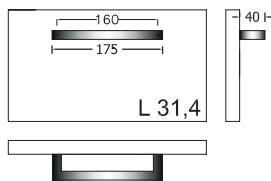

## MANIGLIA VERTICALE HANDLE VERTICAL



Maniglia M42V finitura nichel satinata  
 passo in funzione dell'anta  
 Handle M42V nickel satin finish  
 centre-to-centre distance varies according to the door

**N.B.:** la maniglia verticale non è disponibile per tutti gli elementi. Non inseribile su pensili, basi con cassetti e cestone  
 Note: The vertical handle is not compatible with all the elements. Is not possible to insert it on the wall units and base units with drawers and deep drawers.

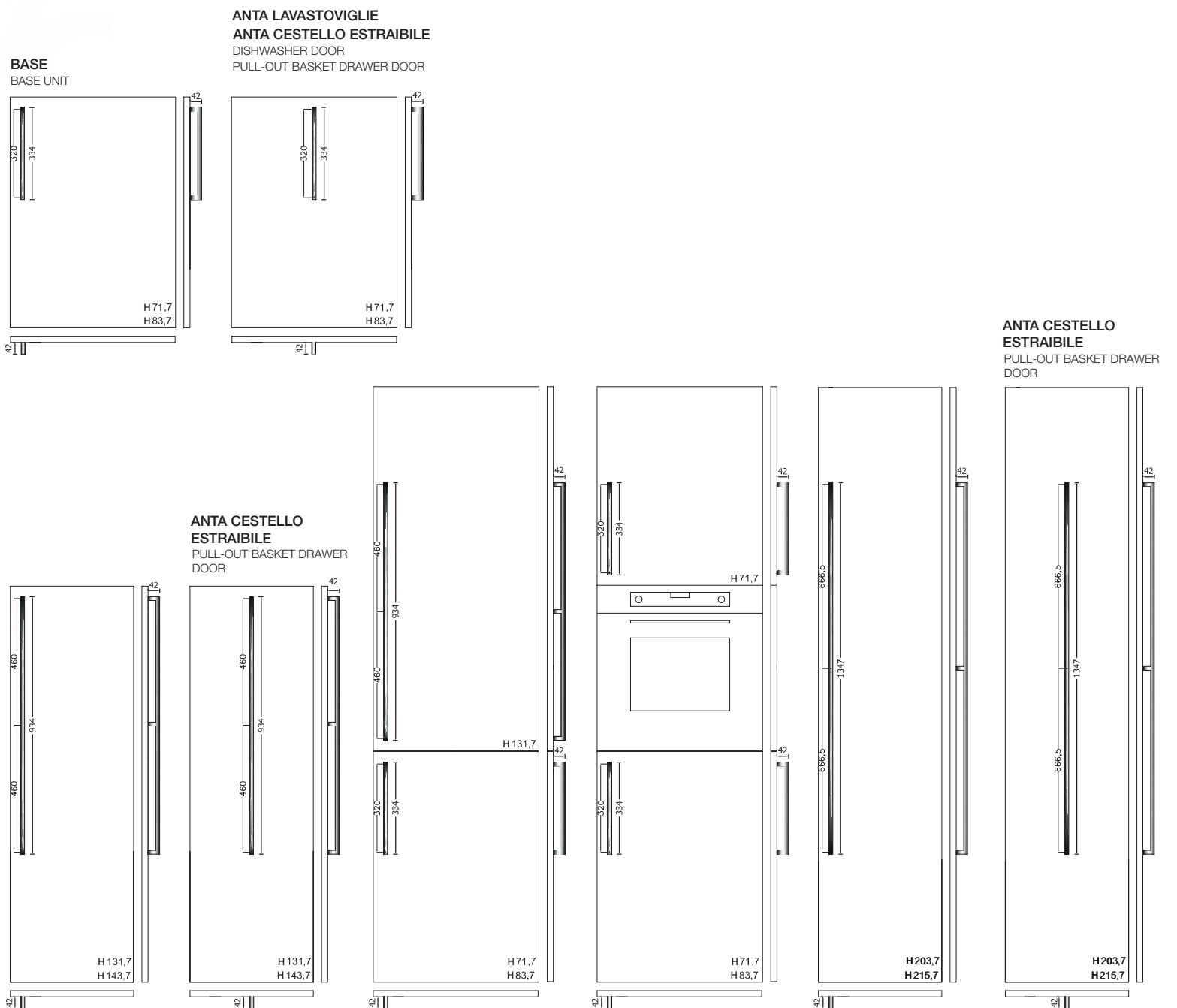



## MANIGLIA VERTICALE HANDLE VERTICAL



Maniglia con saldatura a vista negli angoli  
Handle with visible welding in the corners

Maniglia M41V finitura ferro grezzo  
passo in funzione dell'anta  
Handle M41V unrefined iron finish  
centre-to-centre distance varies according to the door

**N.B.:** la maniglia verticale non è disponibile per tutti gli elementi. Non inseribile su pensili, basi con cassetti e cestone  
**Note:** The vertical handle is not compatible with all the elements. Is not possible to insert it on the wall units and base units with drawers and deep drawers.

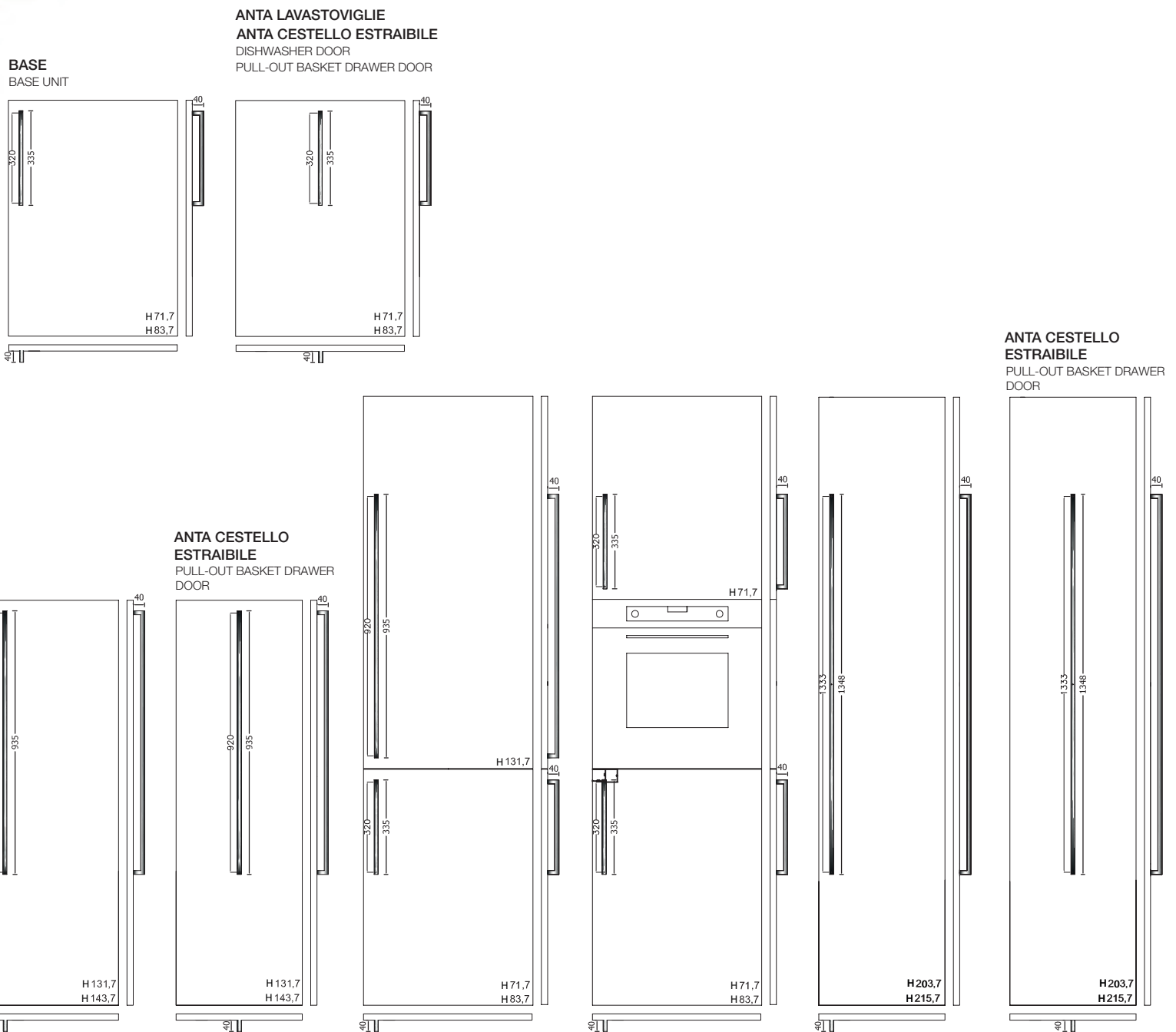

## MANIGLIA FUSION

### FUSION HANDLE

**N.B.: maniglia inseribile solo per le finiture melaminiche con modulistica zoccolo H 6**

Note: handle allowed only for melamine finishes with forms plinth H 6



Maniglia fusion FU11  
finitura nero opaco  
passo in funzione dell'anta  
vedi schema tecnico  
Handle fusion FU11 matt black finish  
centre-to-centre distance varies according  
to the door  
size see technical diagram



particolare maniglia fusion nero opaco  
detail black fusion matt black handle



Maniglia fusion FU12  
finitura titanio  
passo in funzione dell'anta  
vedi schema tecnico  
Handle fusion FU12 titanium finish  
centre-to-centre distance varies according  
to the door  
size see technical diagram



particolare maniglia fusion titanio  
detail titanium fusion handle

## SCHEMA MANIGLIA

### HANDLE DIAGRAM

**N.B.: non inseribile su pensili, basi cassetti e cestoni**  
Note :: not inserted on wall units, base units drawers and deep drawers

#### BASI H 90

BASE UNITS H 90

BASE  
BASE UNIT

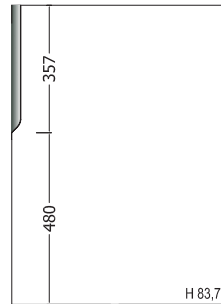

ANTA LAVASTOVIGLIE  
CON SERVO-DRIVE FLEX  
DISHWASHER DOOR  
WITH SERVO-DRIVE FLEX



#### COLONNE H 114-150

COLUMNS H 114-150

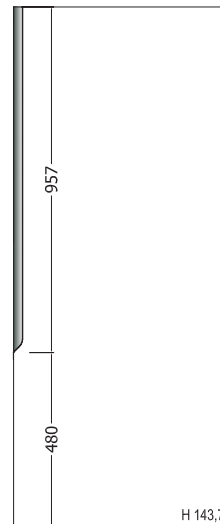
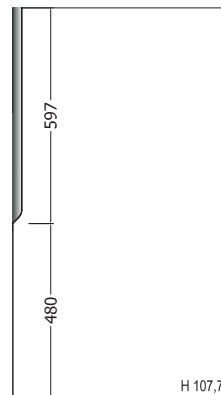

#### COLONNE H 222

COLUMNS H 222

ANTA COLONNA ATTREZZATA  
COLUMN EQUIPPED DOOR

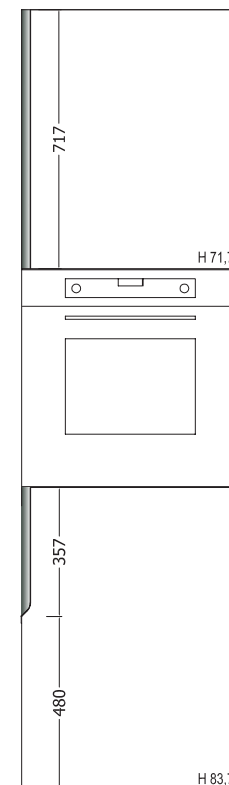
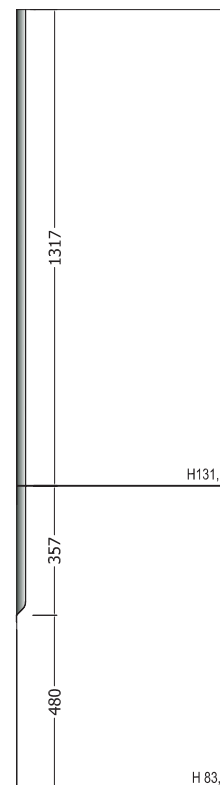
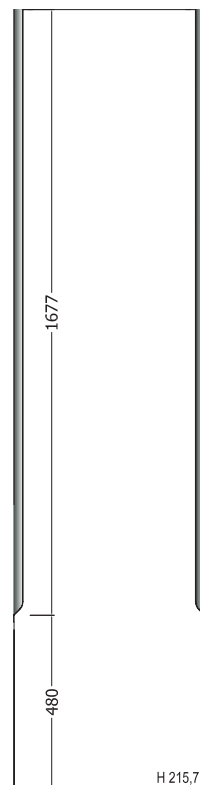
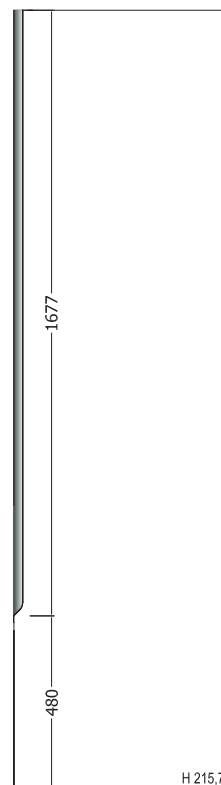

Bridge

# MANIGLIA AD INCASSO "BLEND"

LA COLLEZIONE DELLE MANIGLIE DI **immagina<sup>PLUS</sup>** SI AMPLIA, GRAZIE ALLA NUOVA MANIGLIA **BLEND**. LA FORMA ERGONOMICA E L'INCASSO FANNO DI **BLEND** UNA MANIGLIA CHE GARANTISCE UNO STILE UNICO ALLA CUCINA. È PERSONALIZZABILE INTERNAMENTE CON I VARI COLORI DELLA COLLEZIONE.

## DOOR FOR "BLEND" FRONT RECESSED HANDLE

THE **immagina<sup>PLUS</sup>** COLLECTION OF HANDLES IS GROWING, THANKS TO THE NEW BLEND HANDLE. THE ERGONOMIC SHAPE AND THE RECESS SYSTEM MAKE BLEND THE HANDLE THAT ENSURES A UNIQUE STYLE FOR THE KITCHEN.

THE INTERNAL PART CAN BE CUSTOMISED WITH THE SEVERAL COLOURS OF THE COLLECTION.

## COLORI INTERNI OPACHI MANIGLIA BLEND

INTERNAL MATT COLOURS  
FOR BLEND HANDLE



FINITURA ESTERNA  
TITANIO  
TITANIUM EXTERNAL FINISH



## MANIGLIE HANDLES

---

### DI SERIE STANDARD



Maniglia H01 finitura alluminio satinato  
Handle H01 satin aluminium finish

### A RICHIESTA ON REQUEST



Maniglia H20 finitura cromo  
N.B.: In presenza di questa maniglia  
non si possono tassativamente realizzare fuori misura in larghezza.

Handle H20 chrome finish  
Note: Custom-sized length elements cannot be realized using this handle.



## MANIGLIE HANDLES

---

N.B.: In presenza di questa maniglia non si possono tassativamente realizzare fuori misura in larghezza.  
Note: Custom-sized length elements cannot be realized using this handle.





**SCHEMA MANIGLIE HANDLES DIAGRAM**

**MANIGLIA APPLICATA IN TESTA**  
TOP-MOUNTED HANDLE

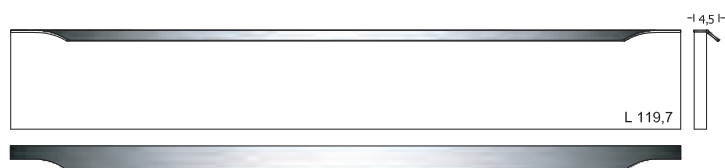
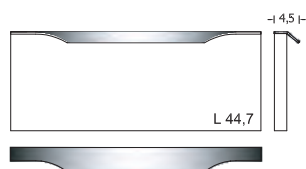
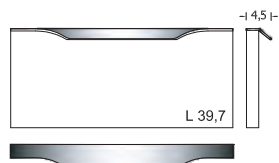
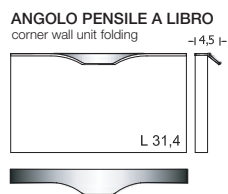
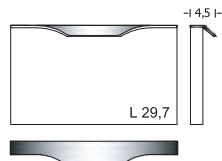

**MANIGLIA FRONTALE PER ANTA COLONNA**  
FRONT DOOR HANDLE FOR COLUMN

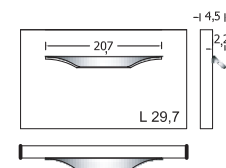
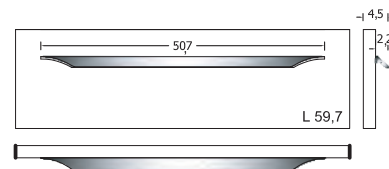
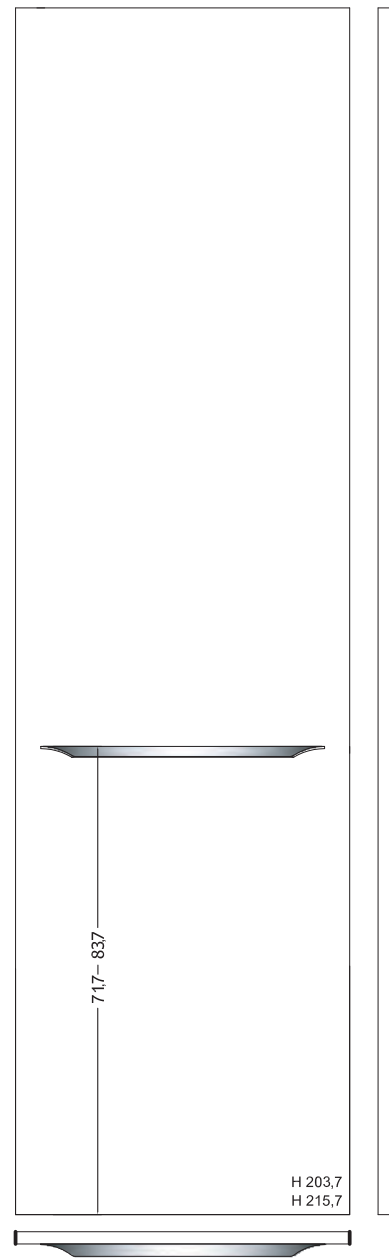

## MANIGLIE HANDLES

---

N.B.: In presenza di questa maniglia  
non si possono tassativamente realizzare fuori misura in larghezza.  
Note: Custom-sized length elements cannot be realized using this handle.



**SCHEMA MANIGLIE HANDLES DIAGRAM**

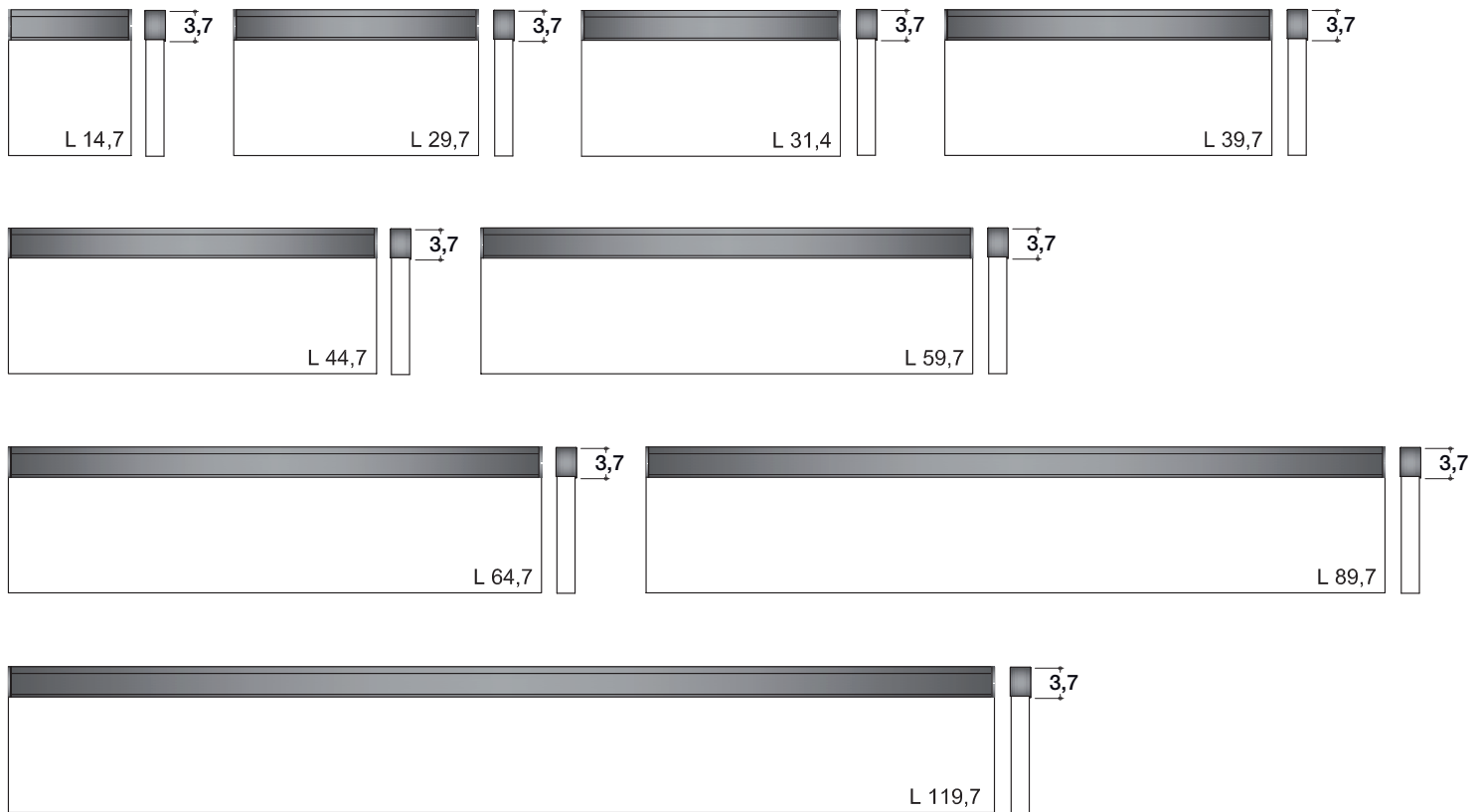

Anta monoporta con maniglia in verticale  
Single-door with handle vertical

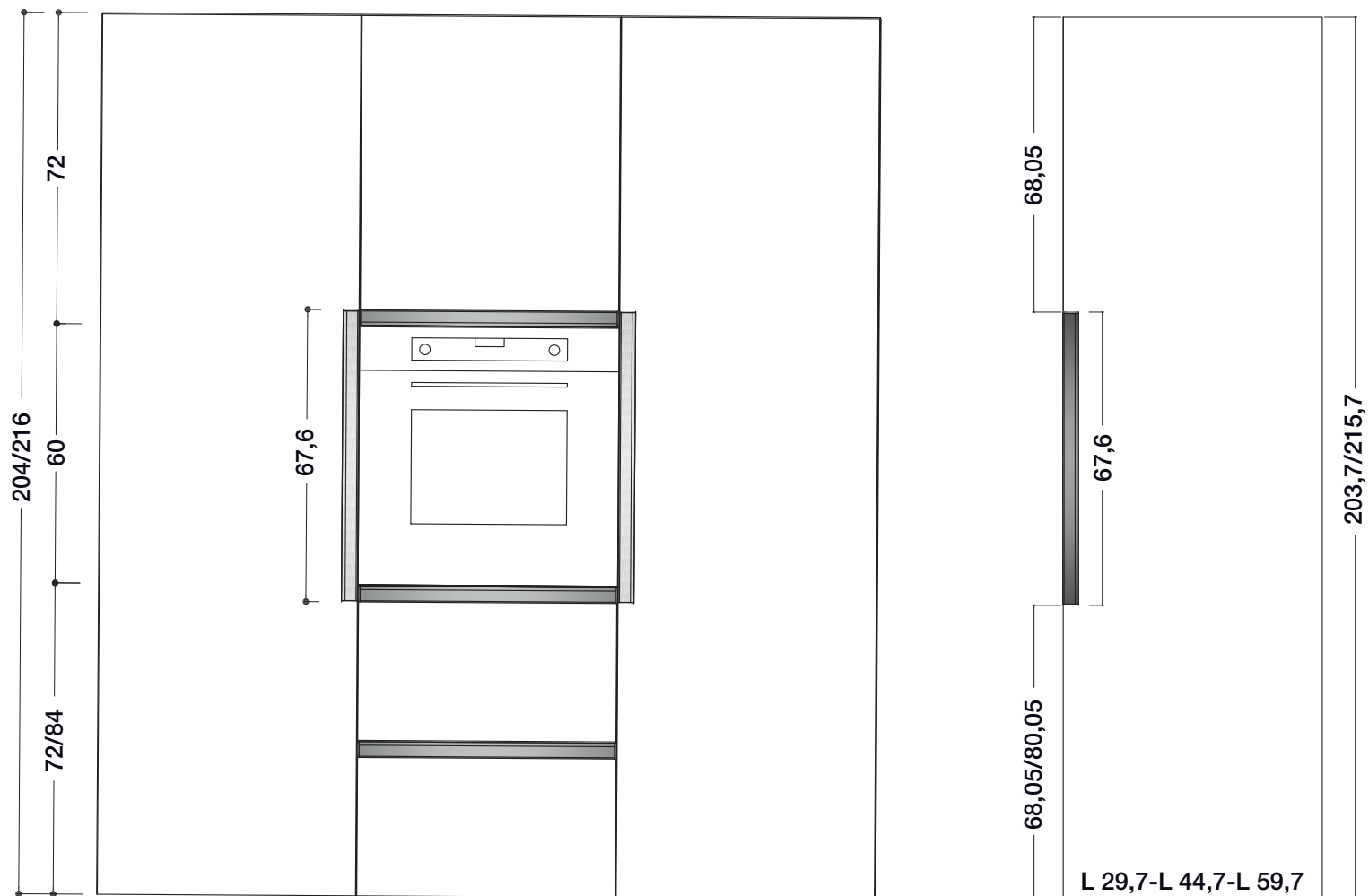

## strutture carcasses



bianco (opz.001)  
schiena e ripiano bianco  
(opz.001)  
white (opt.001)  
white back panel and shelf  
(opt.001)



visone (opz.948M)  
schiena e ripiano visone  
(opz.948M)  
mink (opt.948M)  
mink back panel and shelf  
(opt.948M)



fango (opz.8860)  
schiena e ripiano fango  
(opz.8860)  
mud (opt.8860)  
mud back panel and shelf  
(opt.8860)



lavagna (opz.9620)  
schiena e ripiano lavagna  
(opz.9620)  
slate grey (opt.9620)  
slate grey back panel  
and shelf (opt.9620)

NEW

NEW



conchiglia (opz.8910)  
schiena e ripiano conchiglia  
(opz.8910)  
shell (opt.8910)  
shell back panel and shelf  
(opt.8910)



argilla (opz.9690)  
schiena e ripiano argilla  
(opz.9690)  
clay (opt.9690)  
clay back panel and shelf  
(opt.9690)

N.B.: prodotti conformi al regolamento US EPA TSCA Title VI riguardo emissione formaldeide

Note: products are compliant with US EPA TSCA TITLE VI regulations governing formaldehyde emissions



### LUBE ECOLOGIC

IL GRUPPO LUBE HA SCELTO DI UTILIZZARE PER I COMPONENTI COSTITUENTI LE STRUTTURE DELLE CUCINE SOLO MATERIALE A BASSISSIMA EMISSIONE DI FORMALDEIDE: CONFORMI ALLO STANDARD F\*\*\*\* SECONDO LA NORMA JIS, CERTIFICATO DAL MINISTERO GIAPPONESE, IL PIU' SEVERO IN MERITO ALLE NORMATIVE DI SALVAGUARDIA AMBIENTALE.

LUBE GROUP HAS CHOSEN TO EXCLUSIVELY USE MATERIALS WITH VERY LOW FORMALDEHYDE EMISSIONS FOR THE COMPONENTS MAKING UP THE KITCHEN CARCASSES: THESE ELEMENTS COMPLY WITH THE F4 STAR STANDARD ACCORDING TO JIS, CERTIFIED BY THE JAPANESE GOVERNMENT - THE MOST STRINGENT WHEN IT COMES TO ENVIRONMENTAL PROTECTION.

## mensole in laminato P 31-61 come strutture

same colours as carcasses laminate shelves D 31-61



bianco (opz.001)  
white (opt.001)



visone (opz.948M)  
mink (opt.948M)

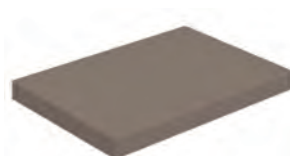

fango (opz.8860)  
mud (opt.8860)



lavagna (opz.9620)  
slate grey (opt.9620)

NEW

NEW



conchiglia (opz.8910)  
shell (opt.8910)

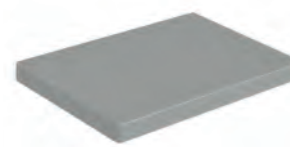

argilla (opz.9690)  
clay (opt.9690)

---

## mensole P 31-61 in melaminico

melamine shelves D 31-61



colori come ante  
colours same as door

---

## mensole P 31-61 laccate opache

matt lacquered shelves D 31-61

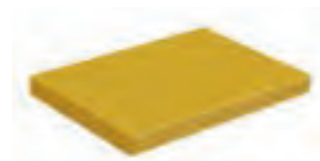

colori come ante  
colours same as door

---

## mensole P 31-61 in acrilico

acrylic shelves D 31-61

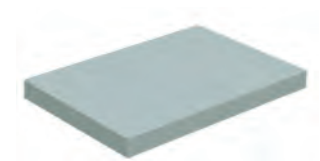

colori come ante  
colours same as door

---

## mensole P 31-61 in glaks

glaks shelves D 31-61



colori come ante  
colours same as door



particolare mensola  
particular shelf

---

## mensole in polimerico P 31

polymeric shelves D 31

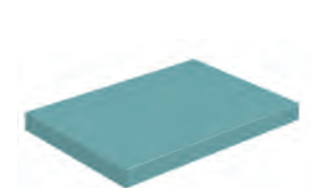

acquamarina (opz.8323)  
aquamarine (opt.8323)

### COLORI COLOURS

acquamarina (opz.8323) aquamarine	giallo ambra (opz.8225) amber yellow	rosa quarzo (opz.8171) quartz pink
salvia (opz.8443) sage	rosso corallo (opz.8131) coral red	bianco assoluto (opz.740P) absolute white

---

## zoccoli in pvc H 13 pvc plinths H 13

di serie  
standard



acciaio (opz.407)  
steel (opt.407)

alluminio satinato  
(opz.405)  
satin aluminium  
(opt.405)

bianco (opz.001)  
white (opt.001)

---

## zoccoli in alluminio H 13 aluminium plinths H 13



alluminio  
finitura brill (opz.412)  
aluminium  
brill finish (opt.412)

alluminio finitura titanio  
ossidato (opz.414)  
aluminium titanium  
oxidized finish (opt.414)

urban ossidato  
(opz.NU)  
urban oxidized finish  
(opt.NU)

## zoccoli in alluminio H 13 verniciati a polvere finitura opaca aluminium plinths H 13 powder coated matt finish



alluminio finitura nero  
(opz.7892)  
aluminium  
black finish (opt.7892)

alluminio finitura fumo  
(opz.9531)  
aluminium  
smoke finish (opt.9531)

alluminio finitura  
bianco caldo (opz.7401)  
aluminium warm white  
finish (opt.7401)

alluminio finitura  
bianco assoluto (opz.740S)  
aluminium absolute  
white finish (opt.740S)



alluminio finitura  
acquamarina  
(opz.8323)  
aluminium aquamarine  
finish (opt.8323)

alluminio finitura giallo  
ambra (opz.8225)  
aluminium amber  
yellow finish (opt.8225)

alluminio finitura salvia  
(opz.8443)  
aluminium sage  
finish (opt.8443)

alluminio finitura rosso  
corallo (opz.8131)  
aluminium coral red  
finish (opt.8131)

alluminio finitura rosa  
quarzo (opz.8171)  
aluminium quartz  
pink finish (opt.8171)



alluminio finitura rosso  
toscano (opz.8157)  
aluminium tuscan red  
finish (opt.8157)

alluminio finitura  
grigio bromo (opz.9533)  
aluminium bromine grey  
finish (opt.9533)

alluminio finitura  
castoro (opz.8907)  
aluminium beaver  
finish (opt.8907)

alluminio finitura  
argilla (opz.9503)  
aluminium clay  
finish (opt.9503)

alluminio finitura  
cenere (opz.9547)  
aluminium ash  
finish (opt.9547)

NEW



alluminio grigio  
traffico (opz.9511)  
aluminium traffic grey  
finish (opt.9511)

NEW



alluminio finitura  
conchiglia (opz.7403)  
aluminium shell  
finish (opt.7403)

NEW



alluminio finitura  
ghisa (opz.9509)  
aluminium cast iron  
finish (opt.9509)

NEW



alluminio finitura  
giallo mais (opz.8251)  
aluminium corn yellow  
finish (opt.8251)

NEW



alluminio finitura  
grigio piombo  
(opz.9537)  
aluminium lead grey  
finish (opt.9537)



alluminio finitura  
silver dark (opz.9507)  
aluminium dark silver  
finish (opt.9507)



## top H 4 consigliati in laminato bordo ABS 1 recommended laminate worktops H 4 with ABS 1 edge

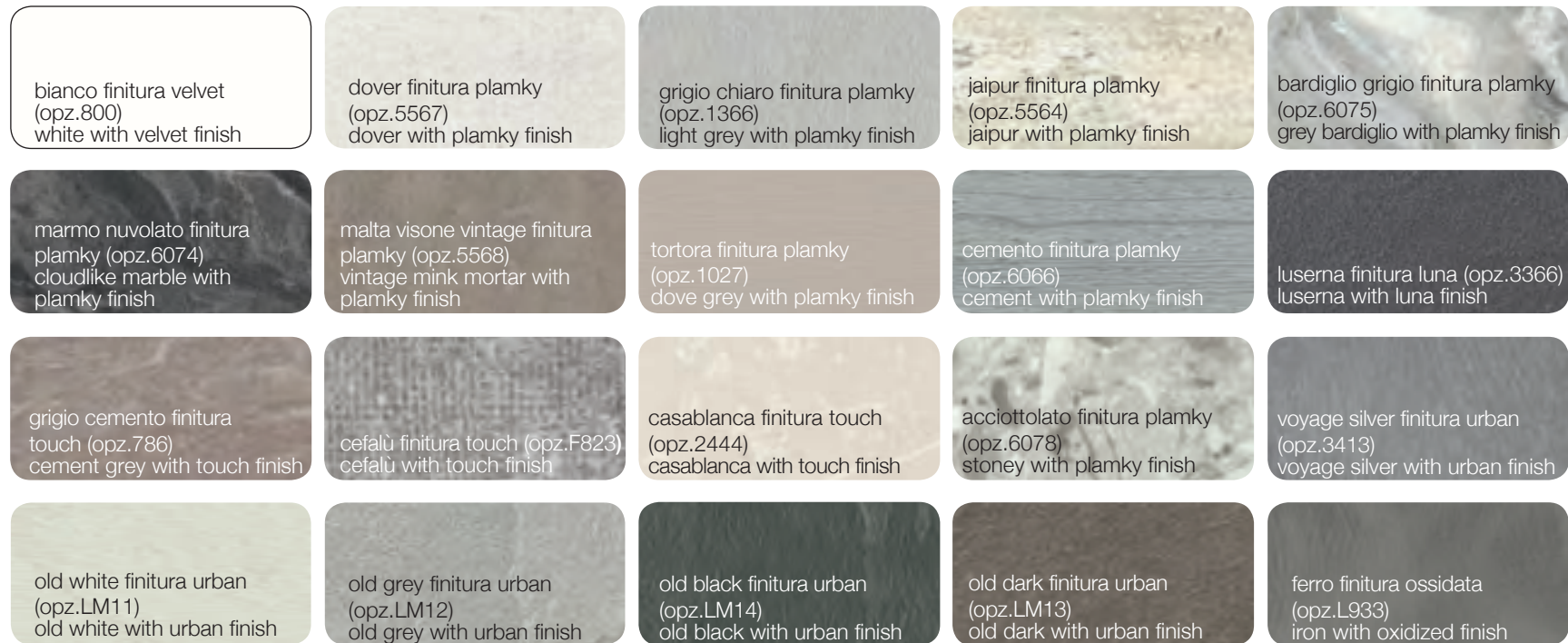

## top H 4 consigliati in laminato Fenix recommended laminate worktops H 4 with Fenix



## top H 4 consigliati in laminato Unicolor recommended laminate worktops H 4 with Unicolor



**consigli per abbinamento dei colori**  
recommended colour combinations

**ante in melaminico**  
malamine doors

**anta in acrilico**  
acrylic door

**elementi a giorno**  
open units

**top**  
worktops

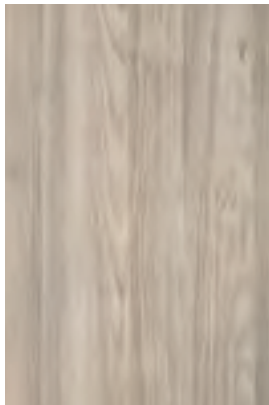

cansiglio sabbia (opt.1564)  
cansiglio sand (opt.1564)

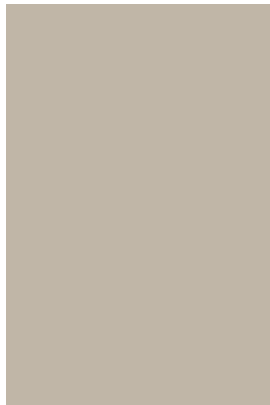

grigio velo (opt.9653)  
veil grey (opt.9653)

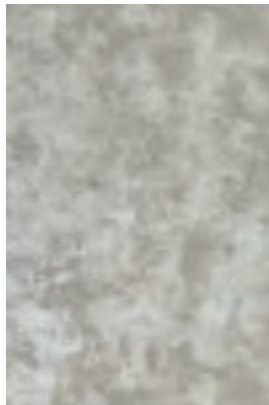

nichel ossidato (opt.9660)  
oxidized nickel (opt.9660)

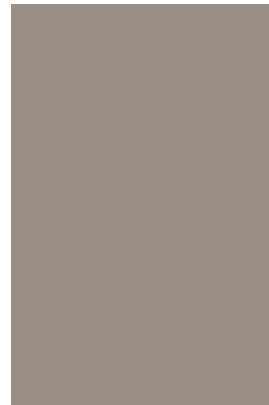

visone opaco (opt.946A)  
matt mink (opt.946A)



giallo ambra (opt.8225)  
amber yellow (opt.8225)



top laminato ABS1tortora  
finitura plamky (opt.1027)  
lamine ABS1 worktop  
dove grey with plamky  
finish (opt.1027)



noce (opt.2363)  
walnut (opt.2363)

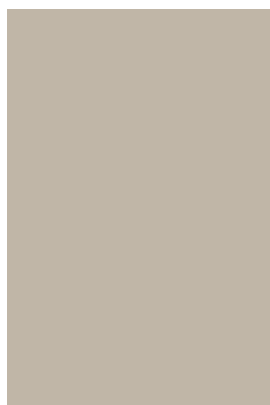

grigio velo (opt.9653)  
veil grey (opt.9653)

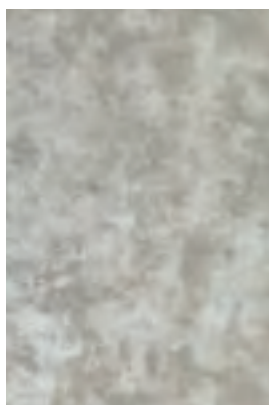

nichel ossidato (opt.9660)  
oxidized nickel (opt.9660)

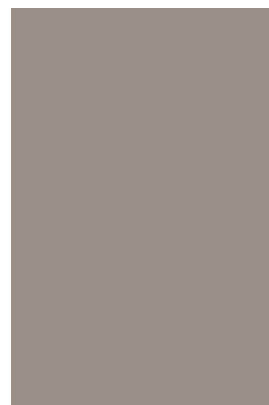

visone opaco (opt.946A)  
matt mink (opt.946A)

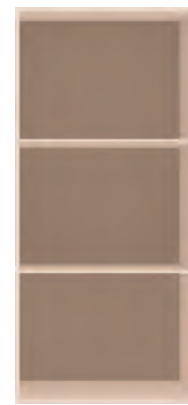

rosa quarzo (opt.8171)  
quartz pink (opt.8171)

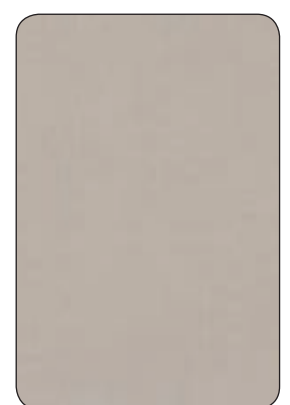

top laminato ABS1tortora  
finitura plamky (opt.1027)  
lamine ABS1 worktop  
dove grey with plamky  
finish (opt.1027)



olmo bianco (opt.5001)  
white elm (opt.5001)

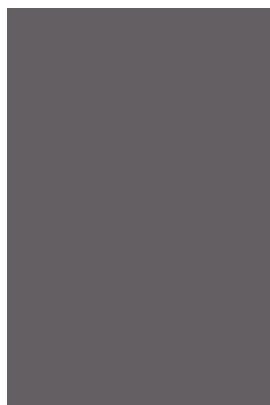

grigio notte (opt.9652)  
midnight grey (opt.9652)



zinco ossidato (opt.9662)  
oxidized zinc (opt.9662)

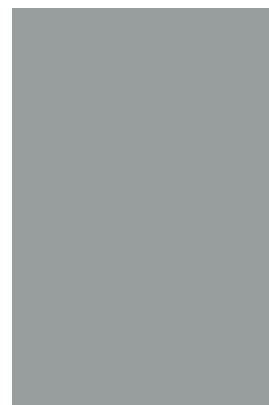

argilla opaco (opt.9573)  
matt clay (opt.9573)

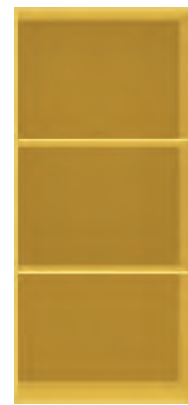

giallo ambra (opt.8225)  
amber yellow (opt.8225)

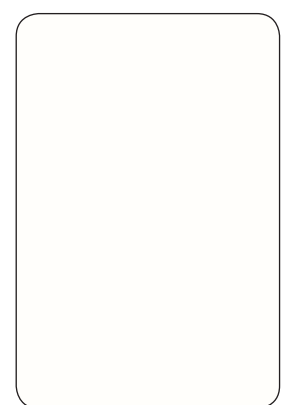

top laminato ABS1 bianco  
finitura velvet (opt.800)  
lamine ABS1 worktop  
white with velvet finish  
(opt.800)

**ante in melaminico**  
malamine doors

**anta in acrilico**  
acrylic door

**elementi a giorno**  
open units

**top**  
worktops



larice vulcano (opz.1828)  
volcano larch (opt.1828)

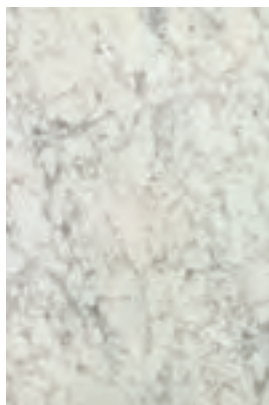

marmo baron (opz.9632)  
baron marble (opt.9632)

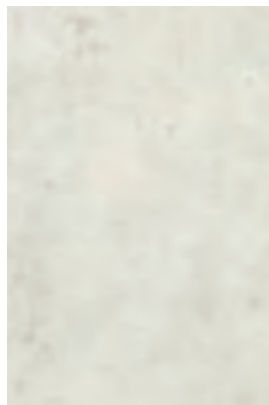

platino ossidato (opz.9661)  
oxidized platinum (opt.9661)



grigio piombo opaco (opz.9569)  
matt lead grey (opt.9569)

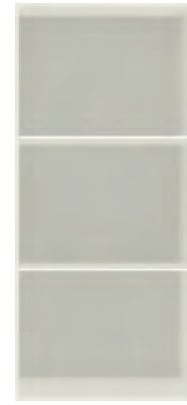

cenere (opz.9547)  
ash (opt.9547)



top laminato ABS1  
bardiglio grigio finitura  
plamky (opz.6075)  
lamine ABS1 worktop  
grey bardiglio with plamky  
finish (opt.6075)



larice laguna (opz.1827)  
lagoon larch (opt.1827)



grigio nebbia finitura  
malta (opz.9626)  
fog grey mortar finish  
(opt.9626)

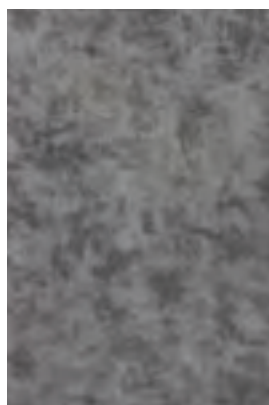

zinco ossidato (opz.9662)  
oxidized zinc (opt.9662)



grigio singapore opaco  
(opz.9575)  
matt singapore grey (opt.9575)



fumo (opz.9531)  
smoke (opt.9531)



top laminato ABS1  
bardiglio grigio finitura  
plamky (opz.6075)  
lamine ABS1 worktop  
grey bardiglio with plamky  
finish (opt.6075)



larice baglia (opz.1826)  
baglia larch (opt.1826)

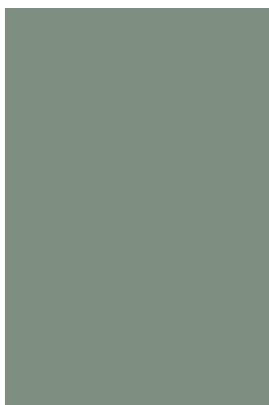

verde marino (opz.8402)  
sea green (opt.8402)

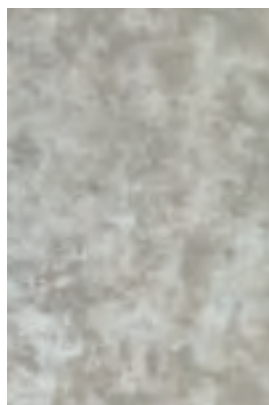

nichel ossidato (opz.9660)  
oxidized nickel (opt.9660)

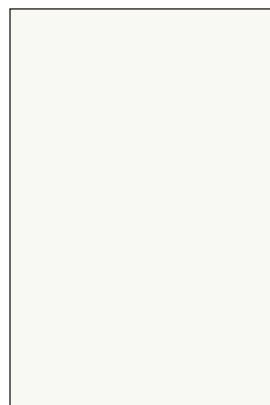

bianco caldo opaco (opz.7497)  
matt warm white (opt.7497)



bianco caldo (opz.7401)  
warm white (opt.7401)



top laminato ABS1  
old dark finitura urban  
(opz.LM13)  
lamine ABS1 worktop  
old dark with urban finish  
(opt.LM13)

**consigli per abbinamento dei colori**  
recommended colour combinations

**ante in melaminico**  
malamine doors



cansiglio grigio fumo (opz. 1563)  
cansiglio smoke grey (opt. 1563)

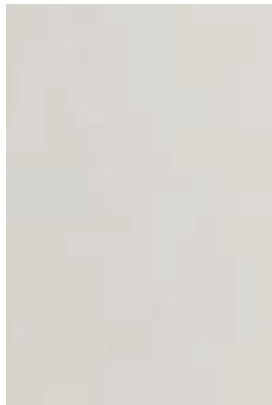

grigio nebbia finitura malta (opz. 9626)  
fog grey mortar finish (opt. 9626)



marmo baron (opz. 9632)  
baron marble (opt. 9632)

**anta in acrilico**  
acrylic door

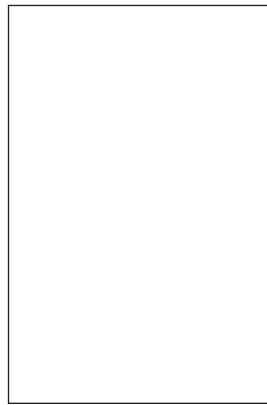

bianco assoluto opaco (opz. 7495)  
matt absolute white (opt. 7495)

**elementi a giorno**  
open units



argilla (opz. 9503)  
clay (opt. 9503)

**top**  
worktops

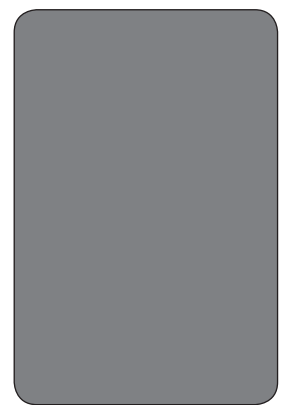

top laminato FENIX grigio antrim (opz. 0752)  
laminato FENIX worktop antrim grey (opt. 0752)



cansiglio bianco (opz. 1561)  
cansiglio white (opt. 1561)

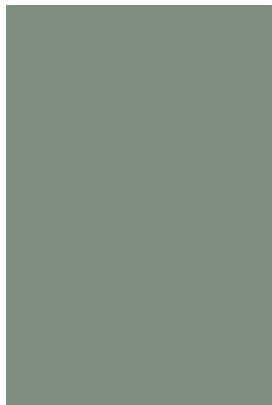

verde marino (opz. 8402)  
sea green (opt. 8402)



zinco ossidato (opz. 9662)  
oxidized zinc (opt. 9662)

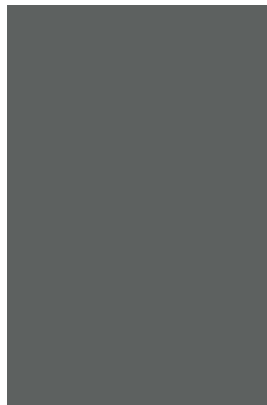

grigio piombo opaco (opz. 9569)  
matt lead grey (opt. 9569)



bianco assoluto (opz. 7409)  
absolute white (opt. 7409)



top laminato ABS1 luserna finitura luna (opz. 3366)  
laminato ABS1 worktop luserna with luna finish (opt. 3366)



cansiglio terra bruciata (opz. 1562)  
cansiglio scorched earth (opt. 1562)



grigio velo (opz. 9653)  
veil grey (opt. 9653)

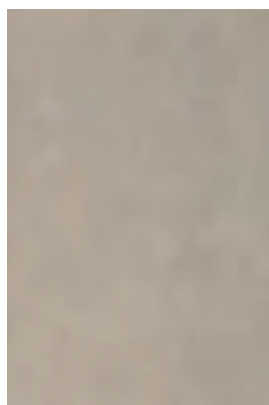

juta finitura malta (opz. 8863)  
jute mortar finish (opt. 8863)

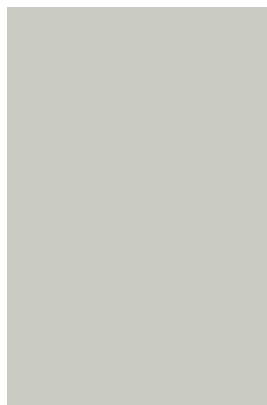

tortora chiaro opaco (opz. 896A)  
matt light dove grey (opt. 896A)



giallo ambra (opz. 8225)  
amber yellow (opt. 8225)

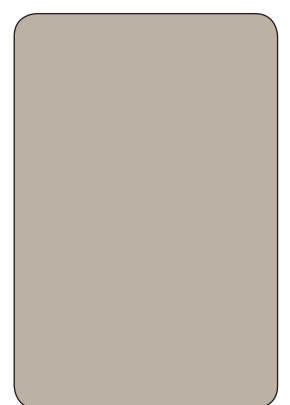

top laminato FENIX beige arizona (opz. 0748)  
laminato FENIX worktop arizona beige (opt. 0748)



**ante in melaminico**  
malamine doors

**anta in acrilico**  
acrylic door

**elementi a giorno**  
open units

**top**  
worktops



noce (opz.2363)  
walnut (opt.2363)

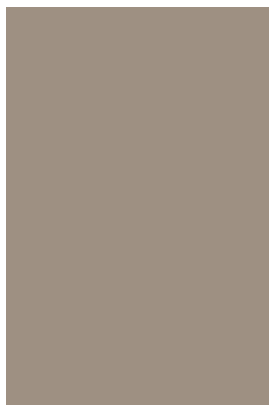

grigio sasso (opz.9650)  
pebble grey (opt.9650)

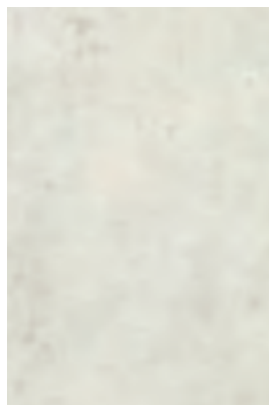

platino ossidato (opz.9661)  
oxidized platinum (opt.9661)



tortora chiaro opaco (opz.896A)  
matt light dove grey (opt.896A)



castoro (opz.8907)  
beaver (opt.8907)



top laminato ABS1  
acciottolato finitura  
plamky (opz.6078)  
laminated ABS1 worktop  
stoney with plamky finish  
(opt.6078)

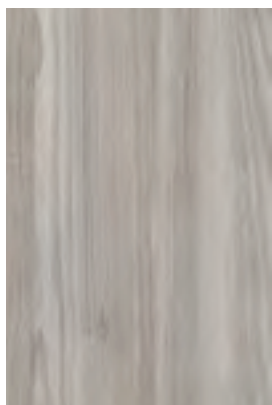

cansiglio grigio fumo  
(opz.1563)  
cansiglio smoke grey  
(opt.1563)



peltro (opz.9666)  
pewter (opt.9666)



grigio nebbia finitura malta  
(opz.9626)  
fog grey mortar finish  
(opt.9626)



argilla opaco (opz.9573)  
matt clay (opt.9573)



cenere (opz.9547)  
ash (opt.9547)

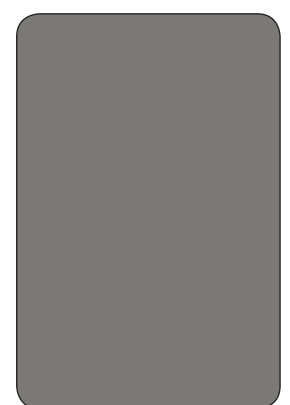

top laminato FENIX  
fumo (opz.0718)  
laminated FENIX worktop  
smoke (opt.0718)



larice laguna (opz.1827)  
lagoon larch (opt.1827)



peltro (opz.9666)  
pewter (opt.9666)

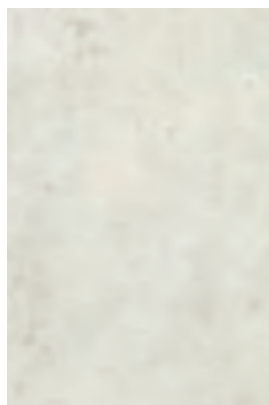

platino ossidato (opz.9661)  
oxidized platinum (opt.9661)

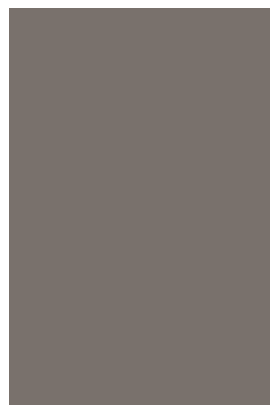

grigio singapore opaco  
(opz.9575)  
matt singapore grey (opt.9575)



fumo (opz.9531)  
smoke (opt.9531)

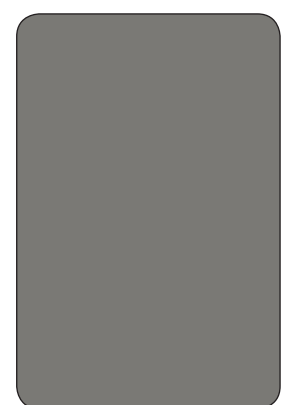

top laminato FENIX  
fumo (opz.0718)  
laminated FENIX worktop  
smoke (opt.0718)

**consigli per abbinamento dei colori**  
recommended colour combinations

**ante in melaminico**  
malamine doors



champagne (opz.1565)  
champagne (opt.1565)



peltro (opz.9666)  
pewter (opt.9666)

**anta laccata**  
lacquered door

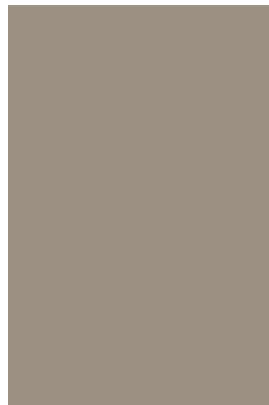

grigio arena opaco  
(opz.9521)  
matt arena grey (opt.9521)

**anta in acrilico**  
acrylic door

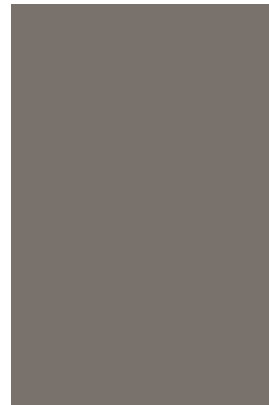

grigio singapore opaco  
(opz.9575)  
matt singapore grey (opt.9575)

**elementi a giorno**  
open units



fumo (opz.9531)  
smoke (opt.9531)

**top**  
worktops

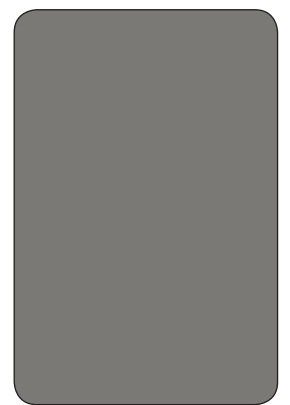

top laminato FENIX  
fumo (opz.0718)  
laminato FENIX worktop  
smoke (opt.0718)

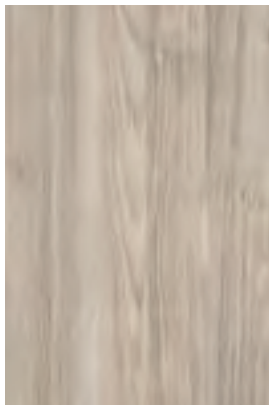

sabbia (opz.1564)  
sand (opt.1564)

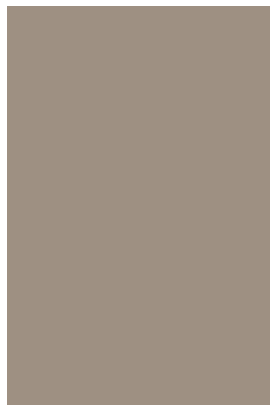

grigio sasso (opz.9650)  
pebble grey (opt.9650)

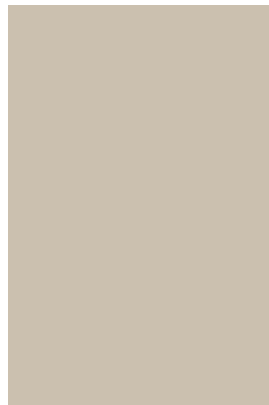

desert opaco (opz.8941)  
matt desert (opt.8941)

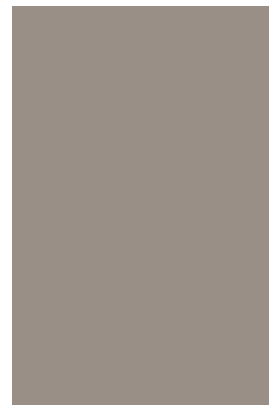

visone opaco (opz.946A)  
matt mink (opt.946A)



cenere (opz.9547)  
ash (opt.9547)



top laminato ABS1  
grigio cemento finitura  
touch (opz.786)  
laminato ABS1 worktop  
cement grey touch finish  
(opt.786)

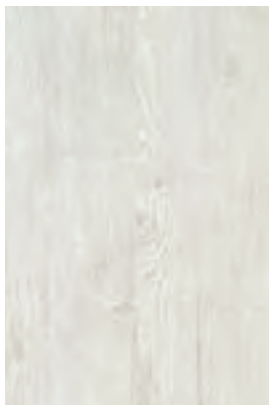

abete bianco (opz.4401)  
white fir (opt.4401)

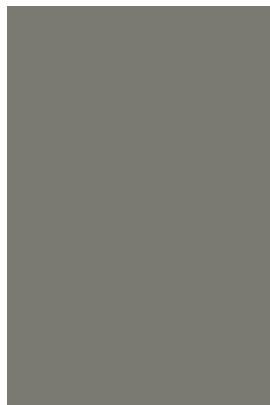

grigio monzone (opz.9651)  
monsoon grey (opt.9651)

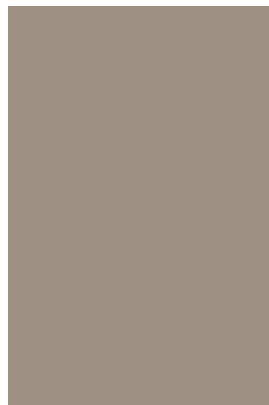

grigio arena opaco  
(opz.9521)  
matt arena grey (opt.9521)

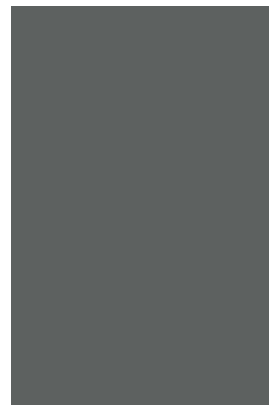

grigio piombo opaco  
(opz.9569)  
matt lead grey (opt.9569)

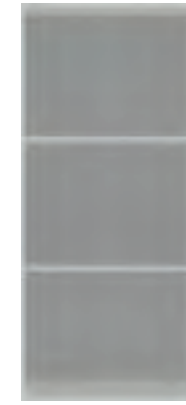

argilla (opz.9503)  
clay (opt.9503)

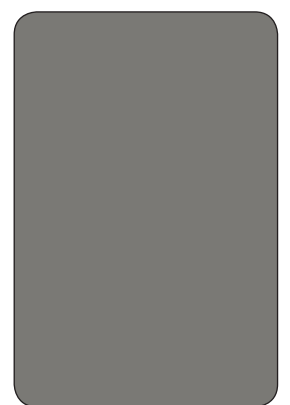

top laminato FENIX  
fumo (opz.0718)  
laminato FENIX worktop  
smoke (opt.0718)



**consigli per abbinamento dei colori**  
recommended colour combinations

**ante in melaminico**  
malamine doors

**anta laccata**  
lacquered door

**anta in acrilico**  
acrylic door

**elementi a giorno**  
open units

**top**  
worktops



cansiglio grigio fumo (opz.1563),  
cansiglio smoke grey (opt.1563)

grigio nebbia finitura malta (opz.9626)  
fog grey mortar finish (opt.9626)

ardesia opaco (opz.9525)  
matt slate grey (opt.9525)

argilla opaco (opz.9573)  
matt clay (opt.9573)

grigio traffico (opz.9511)  
traffic grey (opt.9511)

top laminato FENIX grigio antrim (opz.0752)  
laminare FENIX worktop antrim grey (opt.0752)

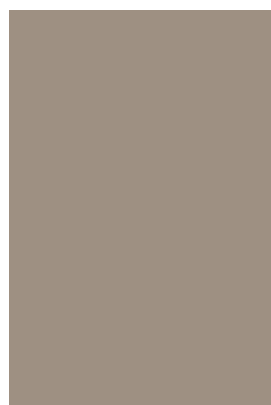

cansiglio bianco (opz.1561)  
cansiglio white (opt.1561)

peltro (opz.9666)  
pewter (opt.9666)

grigio arena opaco (opz.9521)  
matt arena grey (opt.9521)

verde felce opaco (opz.8457)  
matt fern green (opt.8457)

grigio traffico (opz.9511)  
traffic grey (opt.9511)

top laminato FENIX fumo (opz.0718)  
laminare FENIX worktop smoke (opt.0718)

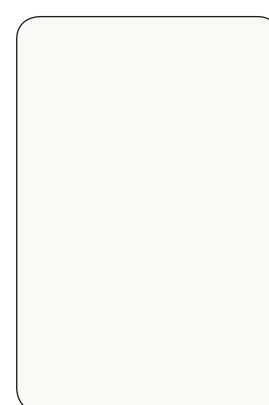
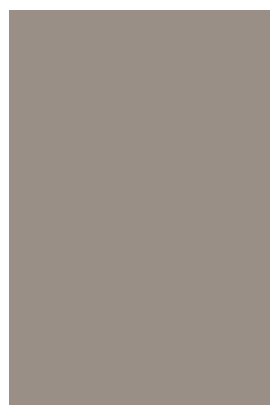
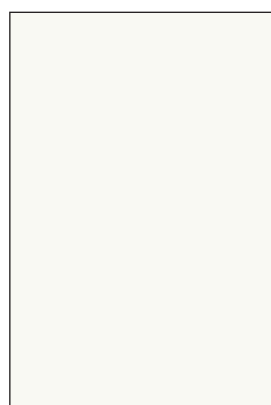

cansiglio terra bruciata (opz.1562)  
cansiglio scorched earth (opt.1562)

grigio velo (opz.9653)  
veil grey (opt.9653)

bianco caldo opaco (opz.7497)  
bianco caldo lucido (opz.7498)  
matt warm white (opt.7497)  
glossy warm white (opt.7498)

visone opaco (opz.946A)  
matt mink (opt.946A)

giallo mais (opz.8251)  
corn yellow (opt.8251)

top laminato FENIX bianco caldo (opz.0032)  
laminare FENIX worktop warm white (opt.0032)

**consigli per abbinamento dei colori**  
recommended colour combinations

**ante in melaminico**  
malamine doors



cansiglio terra bruciata (opz.1562)  
cansiglio scorched earth (opt.1562)

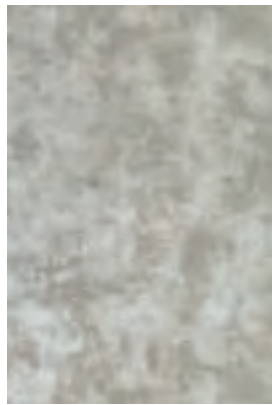

nichel ossidato (opz.9660)  
oxidized nickel (opt.9660)

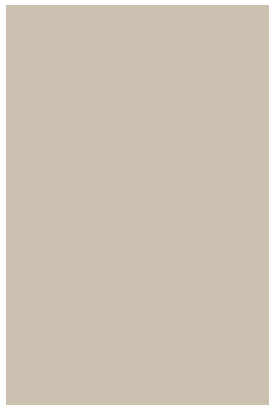

desert opaco (opz.8941)  
matt desert (opt.8941)



tortora chiaro opaco (opz.896A)  
matt light dove grey (opt.896A)

**elementi a giorno**  
open units

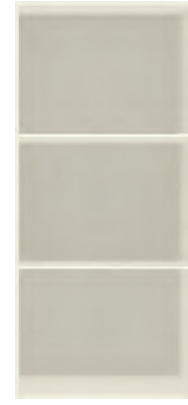

conchiglia (opz.7403)  
shell (opt.7403)

**top**  
worktops



top laminato ABS1  
malta visone vintage  
finitura plamky (opz.5568)  
laminato ABS1 worktop  
vintage mink mortar with  
plamky finish (opt.5568)

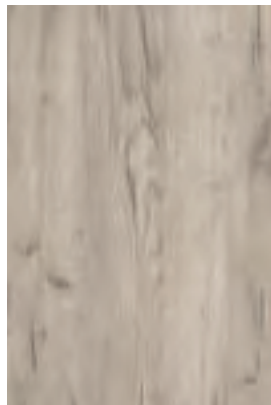

oak cognac (opz.1363)  
cognac oak (opt.1363)

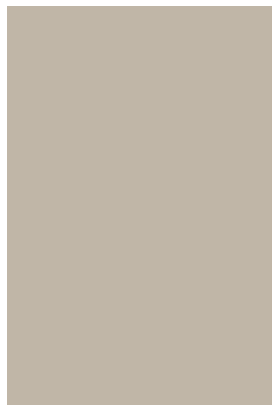

grigio velo (opz.9653)  
veil grey (opt.9653)

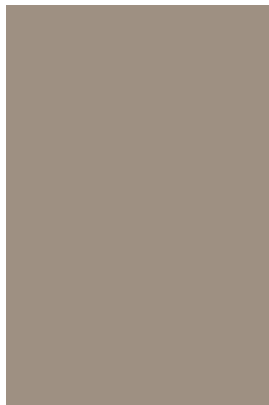

grigio arena opaco (opz.9521)  
matt arena grey (opt.9521)



grigio singapore opaco (opz.9575)  
matt singapore grey (opt.9575)

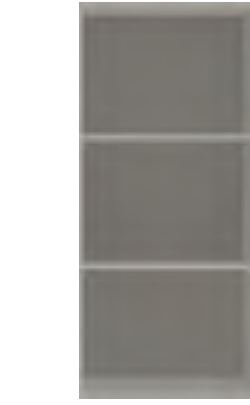

fumo (opz.9531)  
smoke (opt.9531)



top laminato ABS1  
grigio cemento finitura  
touch (opz.786)  
laminato ABS1 worktop  
cement grey touch finish  
(opt.786)



olmo bianco (opz.5001)  
white elm (opt.5001)

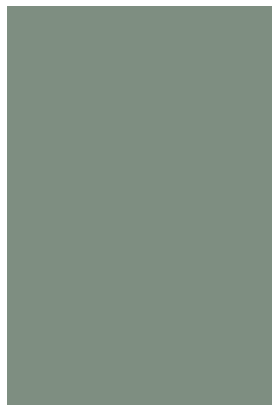

verde marino (opz.8402)  
sea green (opt.8402)

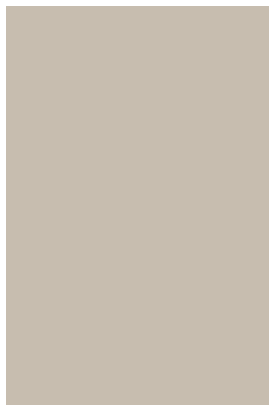

polvere opaco (opz.9529)  
matt dust (opt.9529)

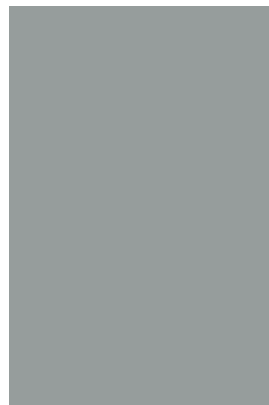

argilla opaco (opz.9573)  
matt clay (opt.9573)



bianco caldo (opz.7401)  
warm white (opt.7401)

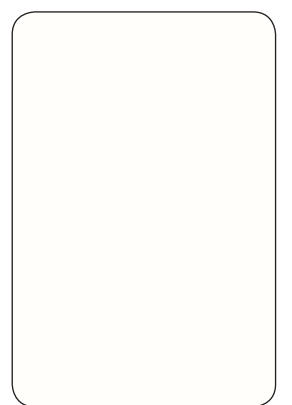

top laminato ABS1 bianco  
finitura velvet (opz.800)  
laminato ABS1 worktop  
white with velvet finish  
(opt.800)

# consigli per abbinamento dei colori

recommended colour combinations

## ante in melaminico

malamine doors



larice terra (opz.1829)  
earth larch (opt.1829)

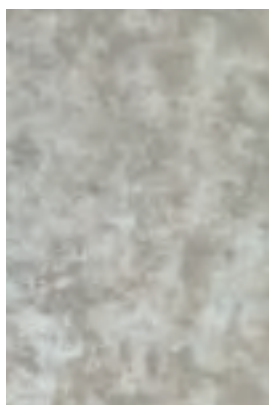

nichel ossidato (opz.9660)  
oxidized nickel (opt.9660)

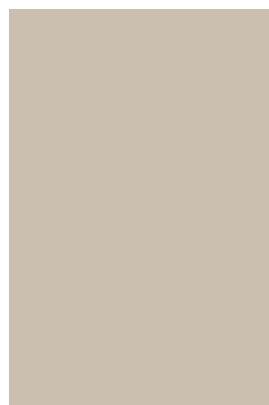

desert opaco (opz.8941)  
matt desert (opt.8941)



visone opaco (opz.946A)  
matt mink (opt.946A)

## elementi a giorno

open units



giallo mais (opz.8251)  
corn yellow (opt.8251)

## top

worktops



top laminato ABS1  
old dark finitura urban  
(opz.LM13)  
laminare ABS1 worktop  
old dark with urban finish  
(opt.LM13)



olmo antracite (opz.5004)  
anthracite elm (opt.5004)



bianco cristallo finitura  
malta (opz.7445)  
crystal white mortar finish  
(opt.7445)



polvere opaco (opz.9529)  
matt dust (opt.9529)



argilla opaco (opz.9573)  
matt clay (opt.9573)



argilla (opz.9503)  
clay (opt.9503)

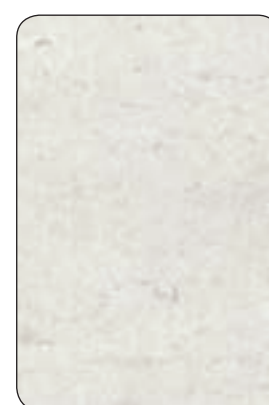

dover finitura plamky  
(opz.5567)  
dover with plamky finish  
(opt.5567)



oak cognac (opz.1363)  
cognac oak (opt.1363)

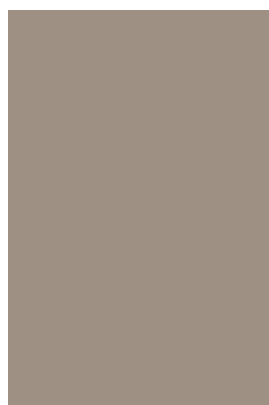

grigio sasso (opz.9650)  
pebble grey (opt.9650)

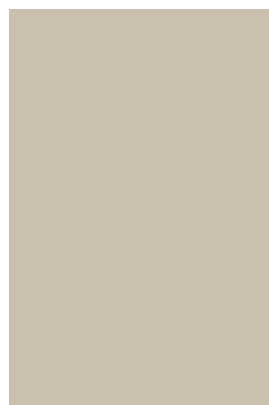

desert opaco (opz.8941)  
matt desert (opt.8941)



visone opaco (opz.946A)  
matt mink (opt.946A)

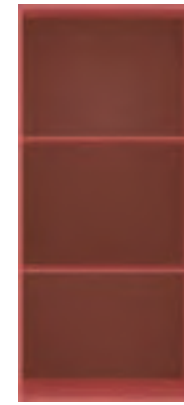

rosso toscano (opz.8157)  
tuscan red (opt.8157)

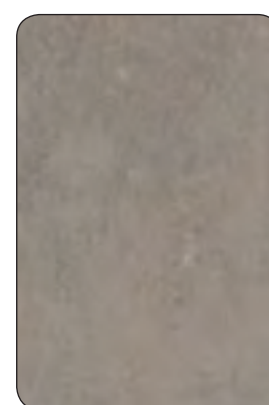

top laminato ABS1  
malta visone vintage  
finitura plamky (opz.5568)  
laminare ABS1 worktop  
vintage mink mortar with  
plamky finish (opt.5568)

**consigli per abbinamento dei colori**  
recommended colour combinations

**ante in melaminico**  
malamine doors

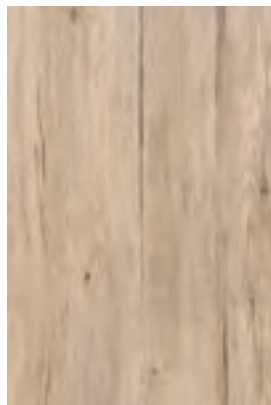

oak miele (opz.1361)  
honey oak (opt.1361)



juta finitura malta (opz.8863)  
jute mortar finish (opt.8863)

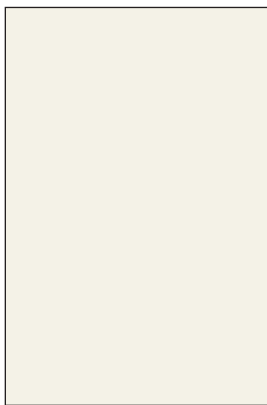

bianco neve opaco (opz.7407)  
matt snow white (opt.7407)

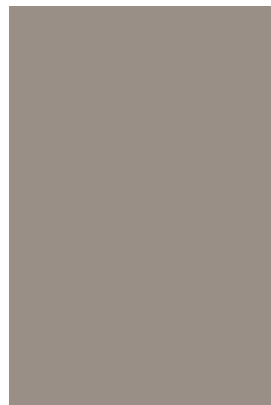

visone opaco (opz.946A)  
matt mink (opt.946A)

**elementi a giorno**  
open units

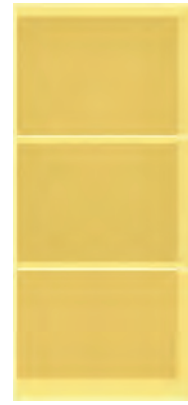

giallo mais (opz.8251)  
corn yellow (opt.8251)

**top**  
worktops



top laminato FENIX bianco malè (opz.0029)  
laminated FENIX worktop malè white (opt.0029)

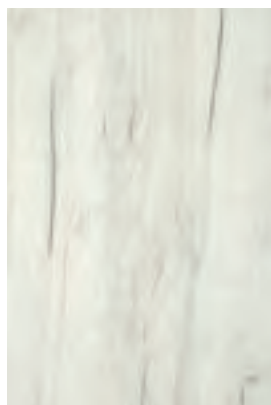

oak neve (opz.1362)  
snow oak (opt.1362)

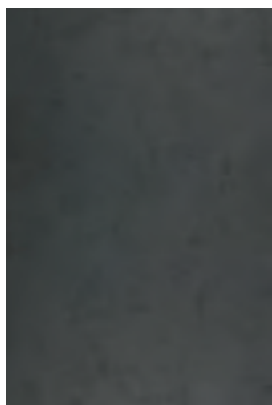

lavagna finitura malta (opz.9627)  
slate grey mortar finish (opt.9627)

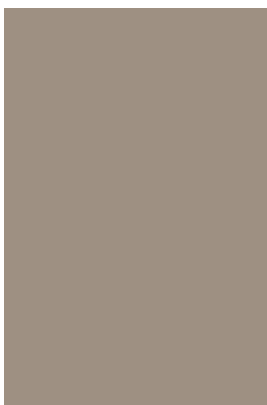

grigio arena opaco (opz.9521)  
matt arena grey (opt.9521)



blu fumo opaco (opz.8353)  
matt smoke blue (opt.8353)



acquamarina (opz.8323)  
aquamarine (opt.8323)

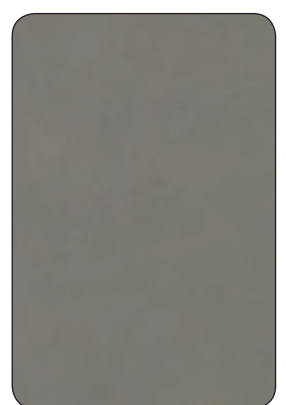

top laminato FENIX fumo (opz.0718)  
laminated FENIX worktop smoke (opt.0718)

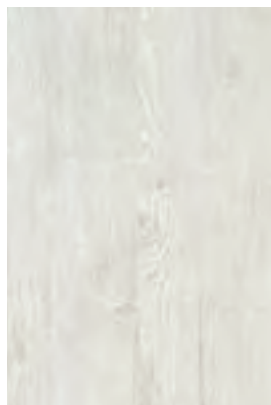

abete bianco (opz.4401)  
white fir (opt.4401)

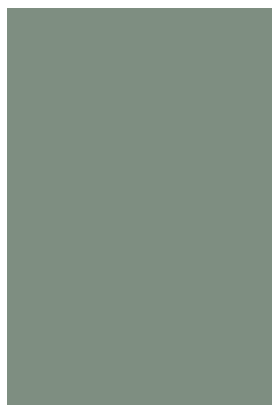

verde marino (opz.8402)  
sea green (opt.8402)

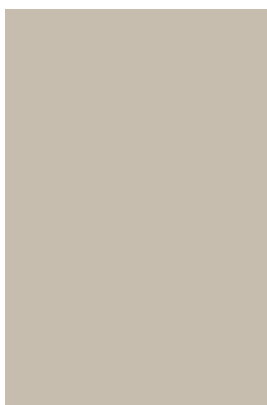

polvere opaco (opz.9529)  
matt dust (opt.9529)

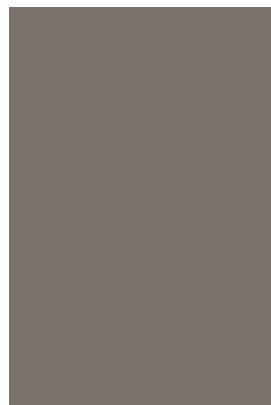

grigio singapore opaco (opz.9575)  
matt singapore grey (opt.9575)



fumo (opz.9531)  
smoke (opt.9531)



top laminato ABS1 voyage silver finitura urban (opz.3413)  
laminated ABS1 worktop voyage silver with urban finish (opt.3413)

**consigli per abbinamento dei colori**  
recommended colour combinations

**ante in melaminico**  
malamine doors

**anta laccata**  
lacquered door

**anta in acrilico**  
acrylic door

**elementi a giorno**  
open units

**top**  
worktops



larice baglia (opz.1826)  
baglia larch (opt.1826)

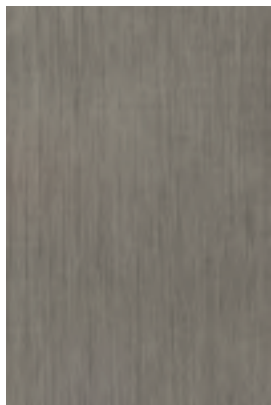

titanio (opz.9665)  
titanium (opt.9665)

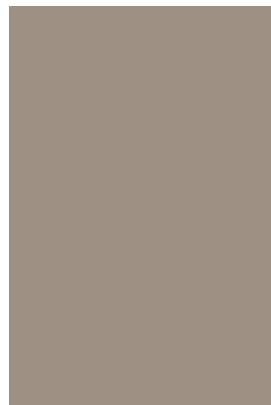

grigio arena opaco (opz.9521)  
matt arena grey (opt.9521)

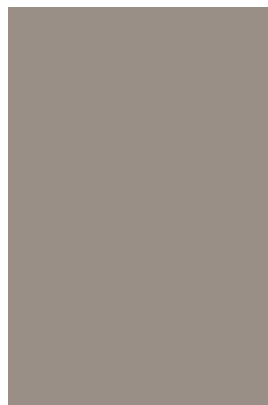

visone opaco (opz.946A)  
matt mink (opt.946A)

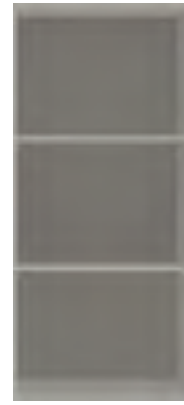

fumo (opz.9531)  
smoke (opt.9531)



top laminato ABS1  
grigio cemento finitura touch (opz.786)  
laminato ABS1 worktop cement grey touch finish (opt.786)



larice terra (opz.1829)  
earth larch (opt.1829)



titanio (opz.9665)  
titanium (opt.9665)

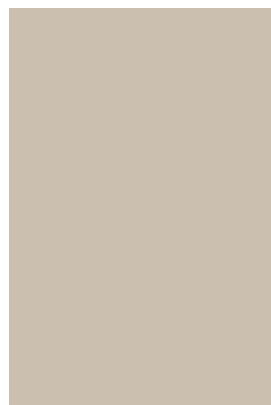

desert opaco (opz.8941)  
matt desert (opt.8941)

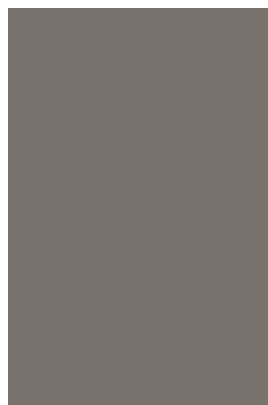

grigio singapore opaco (opz.9575)  
matt singapore grey (opt.9575)

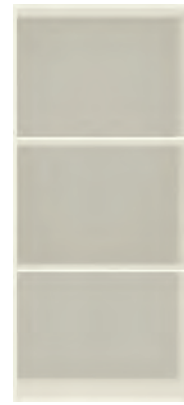

conchiglia (opz.7403)  
shell (opt.7403)



top laminato ABS1  
old dark finitura urban (opz.LM13)  
laminato ABS1 worktop old dark with urban finish (opt.LM13)



noce (opz.2363)  
walnut (opt.2363)

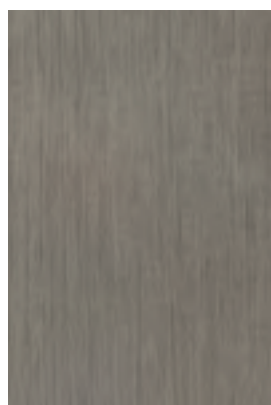

titanio (opz.9665)  
titanium (opt.9665)

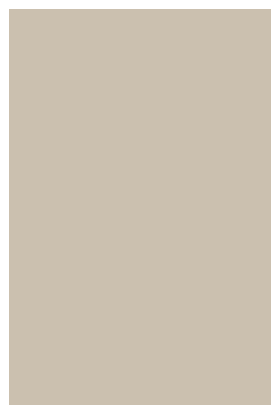

desert (opz.8941)  
desert (opt.8941)

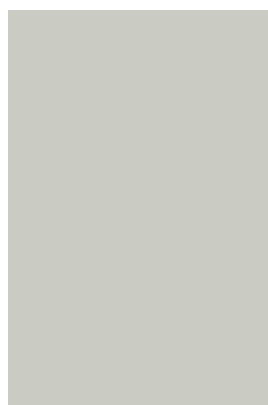

tortora chiaro opaco (opz.896A)  
matt light dove grey (opt.896A)



bianco caldo (opz.7401)  
warm white (opt.7401)



top laminato ABS1  
malta visone vintage finitura plamky (opz.5568)  
laminato ABS1 worktop vintage mink mortar with plamky finish (opt.5568)



## APERTURA A RIBALTA

Le ante aprendosi verso l'alto consentono di avere un' ampia visione d'insieme all'interno del mobile.

La regolazione della forza di apertura può essere impostata in modo esatto in base al peso del frontale. Grazie all'arresto progressivo le ante si fermano in qualsiasi posizione; in questo modo la maniglia è sempre facilmente raggiungibile. La chiusura è ammortizzata e un'unica manovra è sufficiente per regolare il frontale tridimensionalmente grazie all'assenza di cerniere e al sistema di aggancio clip.

WALL UNIT WITH FLAP DOOR

The doors that open upwards guarantee ample overall visibility inside the cabinet.

The opening force can be adjusted precisely according to the weight of the front. The doors stop in any position thanks to the gradual stopping movement; in this way, the handle is always easily accessible. The closing movement is cushioned and a single manoeuvre is required to three-dimensionally adjust the front, thanks to the clip-on system and the absence of hinges.



**DI SERIE**  
STANDARD



**MOTORIZZATO**  
**SERVO-DRIVE**  
SERVO-DRIVE  
MOTORISED  
(Opz.007)



	A	B	C
H 36	11,5	3,5	37
H 48	15	3,5	49
H 60	18,5	3,5	61

Per evitare l'interferenza dell'anta in fase di apertura con cornici o mensole, si può richiedere il limitatore dell'angolo di apertura cod. 5620010

In order to avoid that the door interferes with cornices or shelves during the opening movement, it is possible to request an opening angle limiter: code 5620010

**SCHEMA MONTAGGIO LIMITATORE PER RIBALTA H 36**  
FLAP DOOR LIMITER INSTALLATION DIAGRAM H 36

**SCHEMA MONTAGGIO LIMITATORE PER RIBALTA H 48**  
FLAP DOOR LIMITER INSTALLATION DIAGRAM H 48

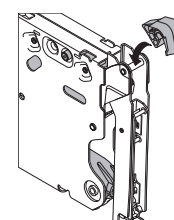
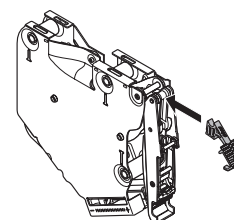

## APERTURA VERTICALE OBLIQUA

I pensili con questo tipo di meccanismo necessitano per l'apertura di poco spazio libero sopra il mobile grazie al movimento basculante dell'anta che si apre senza difficoltà applicando poca forza anche in presenza di frontali pesanti. Con l'arresto progressivo le ante si fermano in qualsiasi posizione; in questo modo la maniglia è sempre facilmente raggiungibile. La chiusura è ammortizzata ed è possibile regolare la forza di tenuta in base al peso del frontale.

VERTICAL OPENING OBLIQUE

Wall units that mount this type of mechanism require little clearance above the cabinet thanks to the swivelling movement of the door that can be easily opened by applying slight pressure, even with heavy fronts. The doors stop in any position thanks to the gradual stopping movement; in this way, the handle is always easily accessible. The closing movement is cushioned and the closing force can be adjusted according to the weight of the front door.



**DI SERIE**  
STANDARD



**MOTORIZZATO**  
**SERVO-DRIVE**  
SERVO-DRIVE  
MOTORISED  
(Opz.007)



	A	B	C	D
H 60	18	9,6	46,5	53,5
H 72	18	9,6	57	61



**APERTURA VERTICALE**

L'anta ad apertura verticale, potendo essere sollevata completamente verso l'alto, consente un accesso totale all'interno del pensile. Ideale per l'impiego in mobili a colonna per nascondere ad esempio apparecchi elettrici, o pensili con corpi mobili sovrastanti, ha la chiusura ammortizzata e la possibilità di regolare la forza di tenuta in base al peso del frontale.

VERTICAL OPENING

Doors with vertical opening movement can be fully raised to fully access the inside of the wall unit. Ideal for use on column units to conceal electrical appliances for examples, or on wall units surmounted by mobile units. The closing movement is cushioned and the closing force can be adjusted according to the weight of the front door.



**DI SERIE STANDARD**



**MOTORIZZATO SERVO-DRIVE**  
SERVO-DRIVE  
MOTORISED



	A	B	C
H 36	34	23,5	34,5
H 48	43	28,5	43,5

**APERTURA ANTE A PACCHETTO**

Il meccanismo d'apertura ante a pacchetto è idoneo sul pensile H 72; la regolazione della forza di apertura può essere impostata in modo esatto in base ai pesi dei frontali, la chiusura è ammortizzata e la cerniera centrale clip si contraddistingue per l'innovativa tecnologia che garantisce la sicurezza per le dita.

LIFT-UP FOLDING DOORS

The lift-up folding door opening mechanism is suitable for wall units with H 72; the opening force can be adjusted precisely according to the weight of the fronts, while the closing movement is cushioned and the central clip-on hinge features innovative technology for safeguarding the fingers.



**DI SERIE STANDARD**



**MOTORIZZATO SERVO-DRIVE**  
SERVO-DRIVE  
MOTORISED  
(Opz.007)



	A	B	C
H 72	16,5	54	41

**SCHEMA MONTAGGIO LIMITATORE**  
LIMITER INSTALLATION  
DIAGRAM

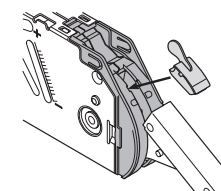

**Per evitare l'interferenza dell'anta in fase di apertura con cornici o mensole, si può richiedere il limitatore dell'angolo di apertura cod. 5620005**

In order to avoid that the door interferes with cornices or shelves during the opening movement, it is possible to request an opening angle limiter: code 5620005

# ELEMENTI TERMINALI STONDATI

ROUNDED END UNITS



colori polimerici opachi disponibili per ripiani e schiena  
 matt polymeric colours available for shelves and back panel

acquamarina (opz.8323) aquamarine	giallo ambra (opz.8225) amber yellow	rosa quarzo (opz.8171) quartz pink	rosso toscano (opz.8157) tuscan red
rosso corallo (opz.8131) coral red	salvia (opz.8443) sage	bianco assoluto (opz.740P) absolute white	

# ELEMENTI A GIORNO SP. 14 MM

OPEN ELEMENTS TH.14 MM



colori polimerici opachi matt polymeric colours

bianco assoluto (opz.740P) absolute white	acquamarina (opz.8323) aquamarine	giallo ambra (opz.8225) amber yellow	rosa quarzo (opz.8171) quartz pink	rosso corallo (opz.8131) coral red	salvia (opz.8443) sage
---	---	--	--	--	------------------------------

colori laccati opachi matt lacquered colours

cenere (opz.9547) ash	grigio traffico (opz.9511) traffic grey	argilla (opz.9503) clay	bianco caldo (opz.7401) warm white	fumo (opz.9531) smoke	<b>NEW</b> giallo mais (opz.8251) corn yellow
grigio piombo (opz.9537) lead grey	castoro (opz.8907) beaver	rosso toscano (opz.8157) tuscan red	grigio bromo (opz.9533) bromine grey	conchiglia (opz.7403) shell	bistro (opz.9535) bistro

colori laccati opachi come anta matt lacquered colours same as door **NEW**

bianco (opz.7405) white	antracite (opz.9558) anthracite	grigio arena (opz.9521) arena grey	rosso vino (opz.8163) wine red	bianco neve (opz.7407) snow white	verde malga (opz.8477) alpine green
desert (opz.8941) desert	polvere (opz.9529) dust	ardesia (opz.9525) slate grey			



# ELEMENTI A GIORNO IN LAMIERA VERNICIATI A POLVERE SP.2 MM

POWDER PAINTED METAL SHEET OPEN UNITS TH.2 MM



colori opachi  
matt colours

<p>bianco assoluto (opz.740S) absolute white</p>	<p>castoro (opz.8907) beaver</p>	<p>acquamarina (opz.8323) aquamarine</p>	<p>giallo ambra (opz.8225) amber yellow</p>	<p>rosa quarzo (opz.8171) quartz pink</p>	<p><b>NEW</b>  ghisa (opz.9509) cast iron</p>
<p>rosso corallo (opz.8131) coral red</p>	<p>salvia (opz.8443) sage</p>	<p>grigio bromo (opz.9533) bromine grey</p>	<p>bianco caldo (opz.7401) warm white</p>	<p>fumo (opz.9531) smoke</p>	<p>bistro (opz.9535) bistro</p>
<p><b>NEW</b>  silver dark (opz.9507) dark silver</p>	<p>rosso toscano (opz.8157) tuscan red</p>	<p>argilla (opz.9503) clay</p>	<p>cenere (opz.9547) ash</p>	<p>grigio traffico (opz.9511) traffic grey</p>	<p>conchiglia (opz.7403) shell</p>
<p><b>NEW</b>  giallo mais (opz.8251) corn yellow</p>	<p>grigio piombo (opz.9537) lead grey</p>				

# PENSILI A COLORAZIONE INTEGRALE CON STRUTTURA FOLDING

FULL COLOUR WALL UNITS WITH FOLDING CARCASS



colori per strutture e ante melaminici  
melamine colours for carcasses and doors

bianco neve (opz.750) snow white	bianco assoluto (opz.7441) absolute white	<b>NEW</b> grigio sasso (opz.9650) pebble grey	<b>NEW</b> verde marino (opz.8402) sea green	<b>NEW</b> grigio monzone (opz.9651) monsoon grey	<b>NEW</b> grigio notte (opz.9652) midnight grey	<b>NEW</b> grigio velo (opz.9653) veil grey
olmo bianco (opz.5001) white elm	olmo antracite (opz.5004) anthracite elm	abete bianco (opz.4401) white fir	oak miele (opz.1361) honey oak	oak neve (opz.1362) snow oak	oak cognac (opz.1363) cognac oak	cansiglio bianco (opz.1561) cansiglio white
cansiglio terra bruciata (opz.1562) cansiglio scorched earth	cansiglio grigio fumo (opz.1563) cansiglio smoke grey	cansiglio sabbia (opz.1564) cansiglio sand	cansiglio champagne (opz.1565) cansiglio champagne	<b>NEW</b> larice baglia (opz.1826) baglia larch	<b>NEW</b> larice laguna (opz.1827) lagoon larch	<b>NEW</b> larice vulcano (opz.1828) volcano larch
<b>NEW</b> larice terra (opz.1829) earth larch	<b>NEW</b> noce (opz.2363) walnut	<b>NEW</b> nichel (opz.9660) nickel	<b>NEW</b> platino (opz.9661) platinum	<b>NEW</b> zinco (opz.9662) zinc	<b>NEW</b> titanio (opz.9665) titanium	<b>NEW</b> marmo baron (opz.9632) baron marble
cemento (opz.9633) cement	lavagna (opz.9627) slate grey	juta (opz.8863) jute	bianco cristallo (opz.7445) cristal white	grigio nebbia (opz.9626) fog grey	castoro (opz.8862) beaver	<b>NEW</b> peltro (opz.9666) pewter

colori per strutture e ante polimerici  
polymeric colours for carcasses and doors

acquamarina (opz.8323) aquamarine	giallo ambra (opz.8225) amber yellow	rosa quarzo (opz.8171) quartz pink
rosso corallo (opz.8131) coral red	salvia (opz.8443) sage	bianco assoluto (opz.740P) absolute white

colori per strutture e ante laccate opache **NEW**  
matt lacquered colours for carcasses and doors

bianco (opz.7405) white	antracite (opz.9558) anthracite	grigio arena (opz.9521) arena grey	rosso vino (opz.8163) wine red
bianco neve (opz.7407) snow white	verde malga (opz.8477) alpine green	desert (opz.8941) desert	polvere (opz.9529) dust
ardesia (opz.9525) slate grey			

# MOBILE DI FINITURA “SIDE”

“SIDE” FINISHING FURNITURE



## COLORI STRUTTURA E COLORI DIVISORI LACCATI OPACHI

CARCASS COLOURS AND MATT LACQUERED DIVIDERS COLOURS

<p>cenere (opz.9547) ash</p>	<p>grigio traffico (opz.9511) traffic grey</p>	<p>argilla (opz.9503) clay</p>	<p>bianco caldo (opz.7401) warm white</p>	<p>fumo (opz.9531) smoke</p>	<p><b>NEW</b></p> <p>giallo mais (opz.8251) corn yellow</p>	<p>bianco assoluto (opz.740S) absolute white</p>
<p>grigio piombo (opz.9537) lead grey</p>	<p>castoro (opz.8907) beaver</p>	<p>rosso toscano (opz.8157) tuscan red</p>	<p>grigio bromo (opz.9533) bromine grey</p>	<p>conchiglia (opz.7403) shell</p>	<p>bistro (opz.9535) bistro</p>	

## COLORI DIVISORI VETRI

GLASS DIVIDERS COLOURS

<p>vetro satinato satin glass</p>	<p>vetro bronzo bronze glass</p>	<p>vetro fumè fumè glass</p>
---------------------------------------	--------------------------------------	----------------------------------



# VIVI IL LIVING

LIVE THE LIVING

Con i nuovi pensili più profondi  
è facilissimo creare composizioni living  
adatte ad ogni spazio.

With new more deep wall units,  
it's easy to create lively  
furnishing compositions.



# LIVING LI01



ANTE  
doors



LARICE LAGUNA  
lagoon larch

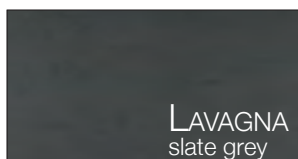

LAVAGNA  
slate grey

ELEMENTI A GIORNO  
open units

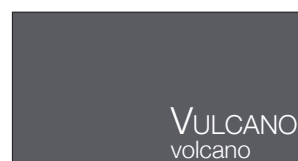

VULCANO  
volcano

STRUTTURE  
carcasses



VISIONE  
mink

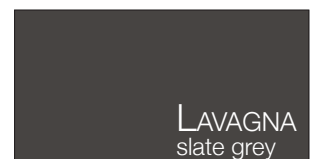

LAVAGNA  
slate grey

# LIVING LI01

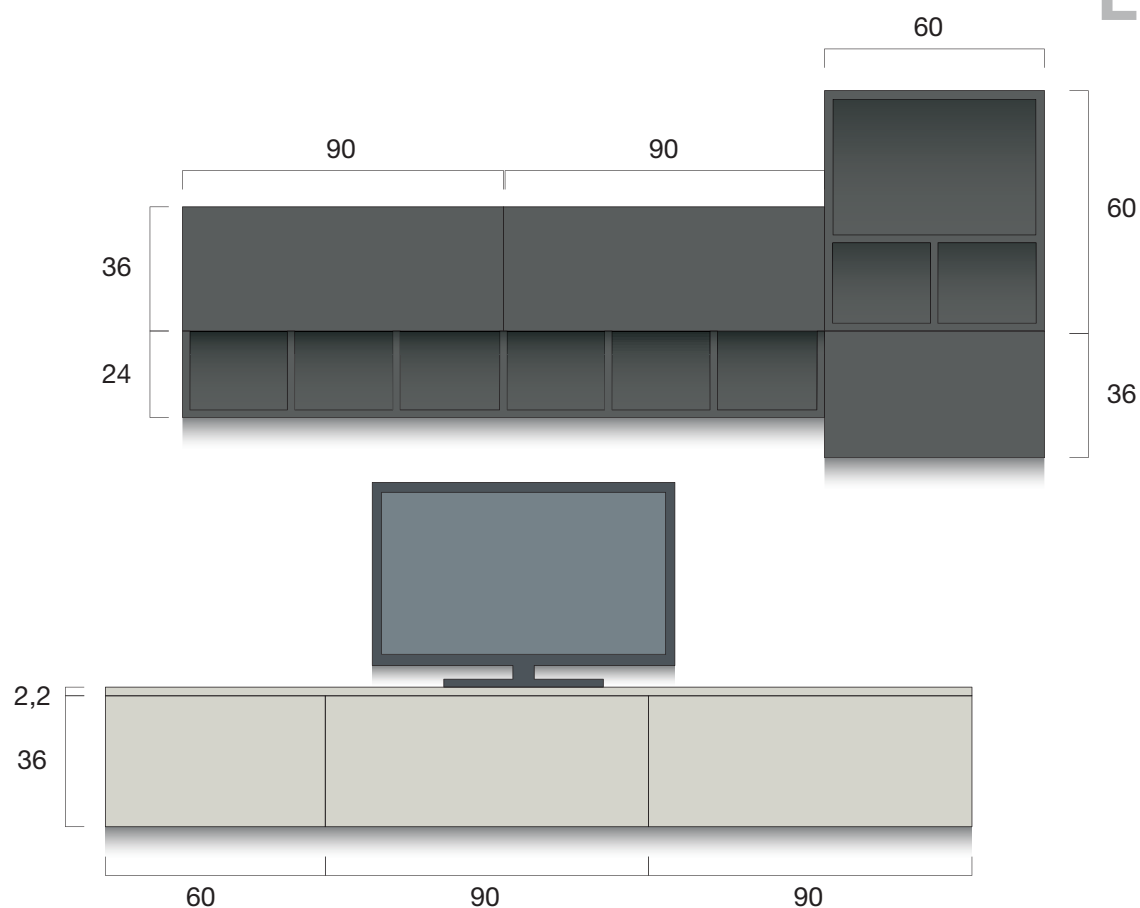

NR. ELEMENTI	DESCRIZIONE	CODICE
1	Pensile L 90 H 36 P 33,4 apertura tip-on,1 fianco come anta	E210090T
1	Pensile L 90 H 36 P 33,4 apertura tip-on	E210090T
2	Elemento a giorno L 90 H 24 P 31 in lamiera verniciata,3 vani	E7710017
1	Elemento a giorno L 60 H 60 P 31 in lamiera verniciata,3 vani	E7710020
1	Pensile L 60 H 36 P 33,4 apertura vasistas	E2106600
1	Pensile L 60 H 36 P 33,4 apertura vasistas,1 fianco come anta	E2106600
1	Pensile L 90 H 36 P 33,4 apertura vasistas	E2106900
1	Pensile L 90 H 36 P 33,4 apertura vasistas,1 fianco come anta	E2106900
1	Top L 240 H 2,2 P 33,4 in melaminico come anta	al ml TLE223
4	Asta appendipensili ml 2	08610501

No. of ELEMENTS	DESCRIPTION	CODE
1	Wall unit W 90 H 36 D 33,4 tip-on opening,1 side same as door	E210090T
1	Wall unit W 90 H 36 D 33,4 tip-on opening	E210090T
2	Painted metal sheet open unit W 90 H 24 D 31,3 compartments	E7710017
1	Painted metal sheet open unit W 60 H 60 D 31,3 compartments	E7710020
1	Wall unit W 60 H 36 D 33,4 flap door opening	E2106600
1	Wall unit W 60 H 36 D 33,4 flap door opening,1 side same as door	E2106600
1	Wall unit W 90 H 36 D 33,4 flap door opening	E2106900
1	Wall unit W 90 H 36 D 33,4 flap door opening,1 side same as door	E2106900
1	Melamine worktop W 240 H 2,2 D 33,4 same as door	per lm TLE223
4	Wall unit fixing strip lm 2	08610501



# LIVING LI02



ANTE  
doors



LARICE BAGLIA  
baglia larch



GRIGIO SASSO  
pebble grey

STRUTTURE  
carcasses



CONCHIGLIA  
shell

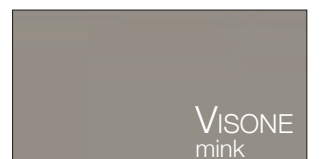

VISONE  
mink

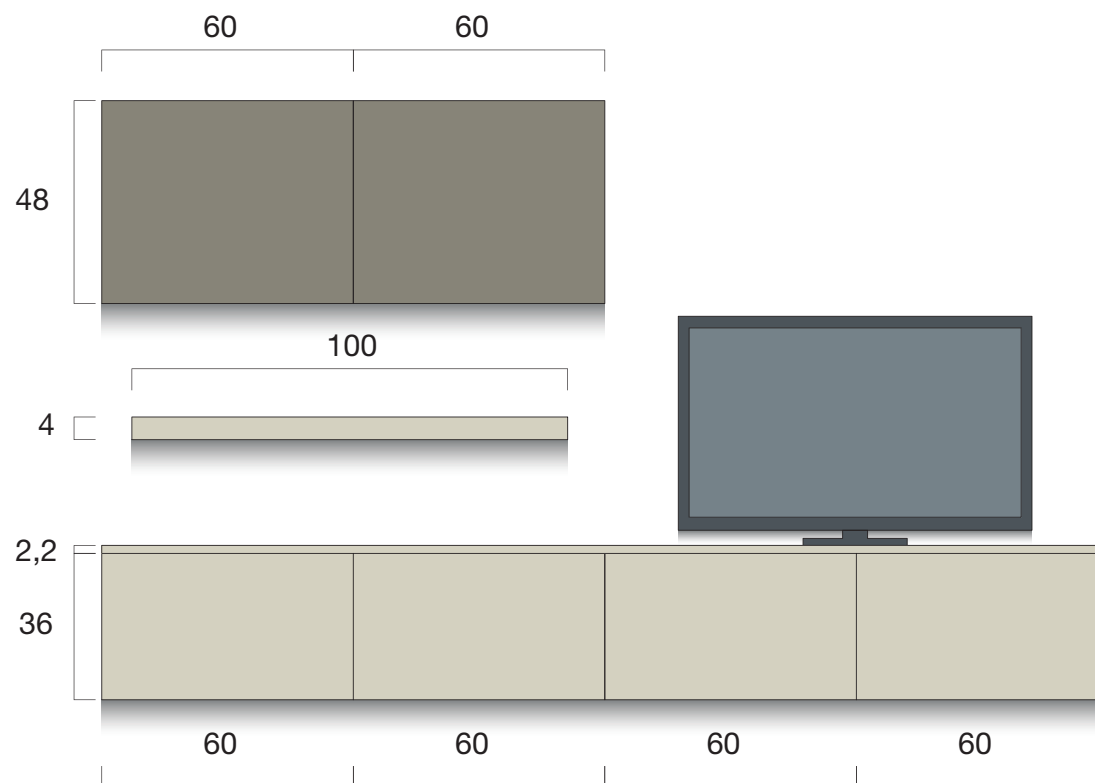

NR. ELEMENTI	DESCRIZIONE	CODICE
2	Pensile L 60 H 48 P 33,4 ribalta tip-on, 1 fianco come anta	E212060T
2	Pensile L 60 H 36 P 33,4 apertura vasistas, 1 fianco come anta	E2106600
2	Pensile L 60 H 36 P 33,4 apertura vasistas	E2106600
1	Top L 240 H 2,2 P 33,4 in melaminico come anta	al ml TLE223
1	Mensola L 100 H 4 P 31 in melaminico come anta	al ml 091523
3	Asta appendipensili ml 2	08610501

No. of ELEMENTS	DESCRIPTION	CODE
2	Wall unit W 60 H 48 D 33,4 flap door tip-on opening, 1 side same as door	E212060T
2	Wall unit W 60 H 36 D 33,4 flap door, 1 side same as door	E2106600
2	Wall unit W 60 H 36 D 33,4 flap door	E2106600
1	Melamine worktop W 240 H 2,2 D 33,4 same as door	per lm TLE223
1	Melamine shelf W 100 H 4 D 31 same as door	per lm 091523
3	Wall unit fixing strip lm 2	08610501



# LIVING LI03



ANTE  
doors

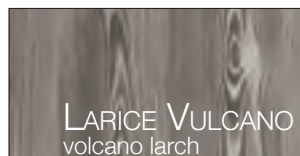

LARICE VULCANO  
volcano larch



GRIGIO NEBBIA  
fog grey

ELEMENTI A GIORNO  
open units

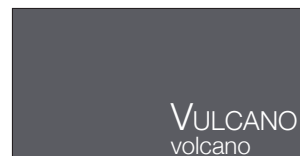

VULCANO  
volcano



BIANCO ASSOLUTO  
absolute white

STRUTTURA  
carcass

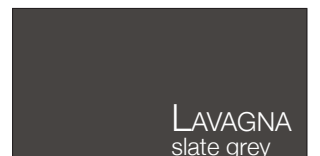

LAVAGNA  
slate grey

# LIVING LI03

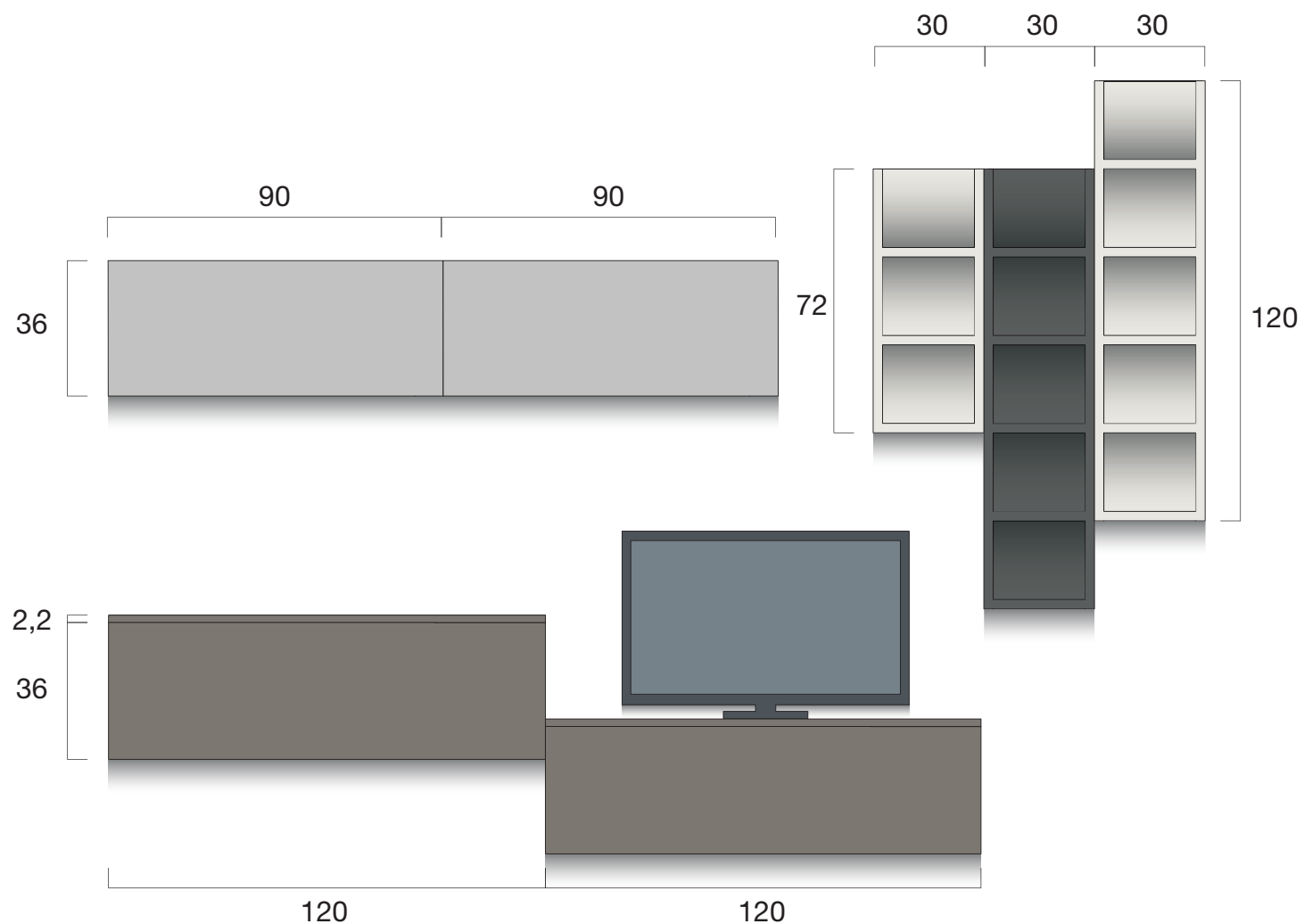

NR. ELEMENTI	DESCRIZIONE	CODICE
2	Pensile L 90 H 36 P 33,4 ribalta tip-on, 1 fianco come anta	E210090T
1	Elemento a giorno L 30 H 72 P 31 in lamiera verniciata, 3 vani	E7710040
2	Elemento a giorno L 30 H 120 P 31 in lamiera verniciata, 5 vani	E7710042
2	Pensile L 120 H 36 P 33,4 apertura vasistas fianchi come anta	E2107200
2	Top L 120 H 2,2 P 33,4 in melaminico come anta	al ml TLE223
3	Asta appendipensili ml 2	08610501

No. of ELEMENTS	DESCRIPTION	CODE
2	Wall unit W 90 H 36 D 33,4 flap door tip-on opening, side same as door	E210090T
1	Painted metal sheet open unit W 30 H 72 D 31, 3 compartments	E7710040
2	Painted metal sheet open unit W 30 H 120 D 31, 5 compartments	E7710042
2	Wall unit W 120 H 36 D 33,4 flap door opening side same as door	E2107200
2	Melamine worktop W 120 H 2,2 D 33,4 same as door	per lm TLE223
3	Wall unit fixing strip lm 2	08610501

# LIVING LI04



ANTE  
doors



ELEMENTI TERMINALI  
end units

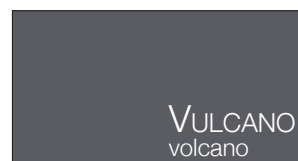

ELEMENTI A GIORNO  
open units



STRUTTURA  
carcass

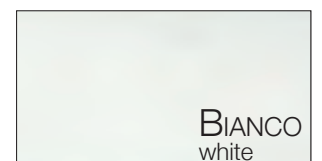

# LIVING LI04

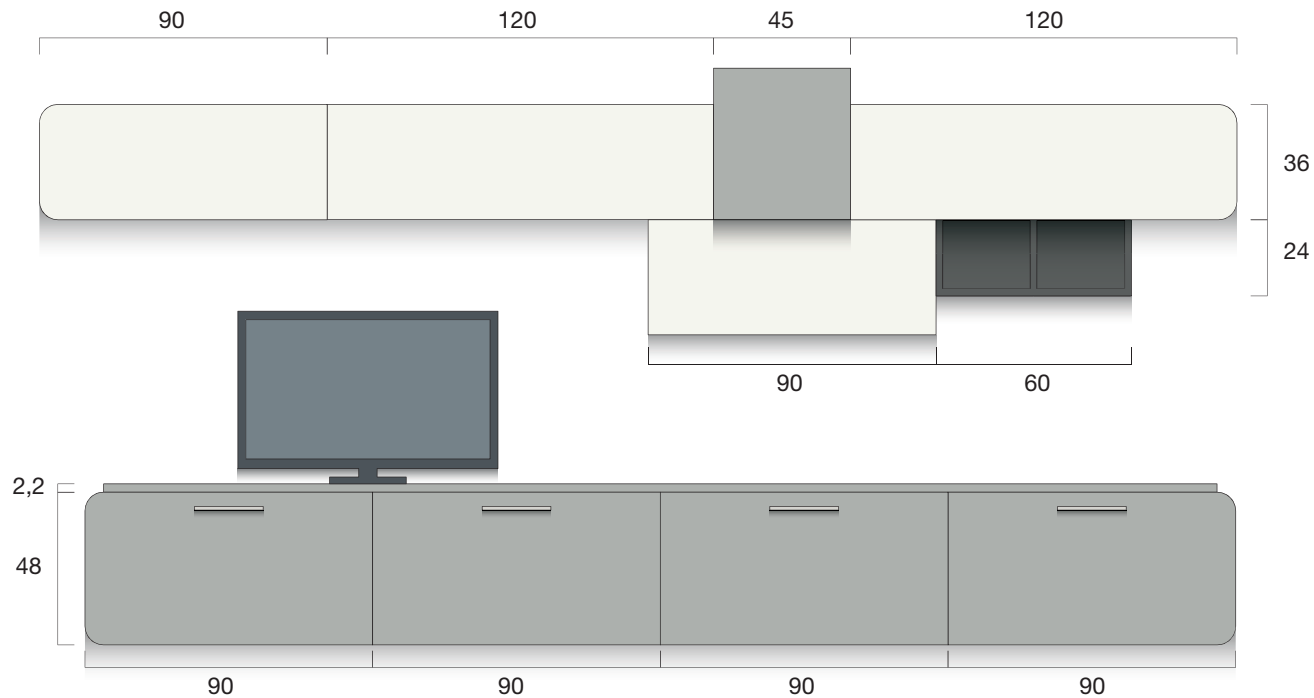

NR. ELEMENTI	DESCRIZIONE	CODICE
1	Pensile L 90 H 36 P 33,4 anta stondata apertura tip-on con terminale a giorno	ETP42901/2
1	Pensile L 120 H 36 P 33,4 apertura tip-on	E210120T
1	Pensile folding L 45 H 48 P 40,4 apertura push-pull	EPF63451/2
1	Pensile L 120 H 36 P 33,4 anta stondata apertura tip-on con terminale a giorno	ETP42951/2
1	Pensile L 90 H 36 P 33,4 apertura vasistas, fianchi come anta	E2106900
1	Elemento a giorno L 60 H 24 P 31 in lamiera verniciata, 2 vani	E7710016
2	Base living sospesa L 90 H 48 P 50,4 cestone anta stondata con terminale a giorno	ETL73901/2
2	Base living sospesa L 90 H 48 P 50,4 cestone	EBL85900
1	Top L 171+171 H 2,2 P 50,4 in melaminico come anta	al ml TLE225
5	Asta appendipensili ml 2	08610501

No. of ELEMENTS	DESCRIPTION	CODE
1	Wall unit W 90 H 36 D 33,4 rounded edge door tip-on opening with open end unit	ETP42901/2
1	Wall unit W 120 H 36 D 33,4 tip-on opening	E210120T
1	Folding wall unit W 45 H 48 D 40,4 push-pull opening	EPF63451/2
1	Wall unit W 120 H 36 D 33,4 rounded edge door tip-on opening with open end unit	ETP42951/2
1	Wall unit W 90 H 36 D 33,4 flap door opening, sides same as door	E2106900
1	Painted metal sheet open unit W 60 H 24 D 31, 2 compartments	E7710016
2	Hanging living base unit W 90 H 48 D 50,4 rounded edge door deep drawer with open end unit	ETL73901/2
2	Hanging living base unit W 90 H 48 D 50,4 deep drawer	EBL85900
1	Melamine worktop W 171+171 H 2,2 D 50,4 same as door	per lm TLE225
5	Wall unit fixing strip lm 2	08610501



# LIVING LI05



ANTE  
doors

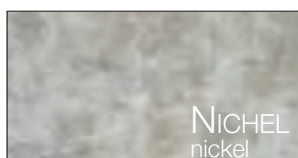

ELEMENTI A GIORNO  
open units

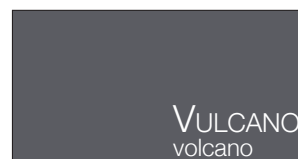

STRUTTURE  
carcasses

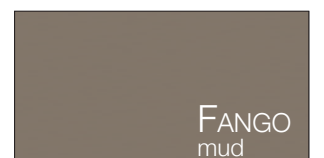
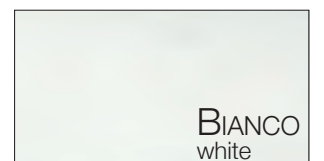



# LIVING LI05

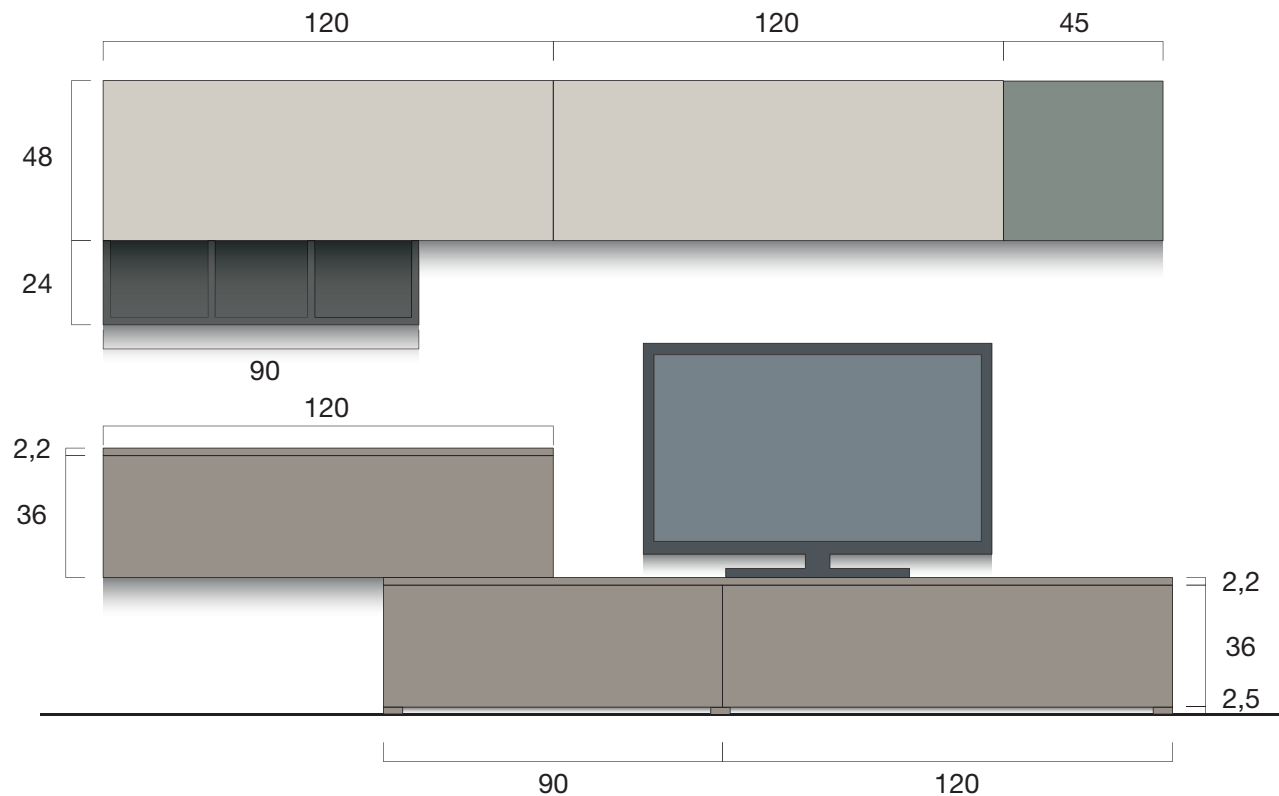

NR. ELEMENTI	DESCRIZIONE	CODICE
1	Pensile L 120 H 48 P 33,4 apertura tip-on, 1 fianco come anta	E212120T
1	Pensile L 120 H 48 P 33,4 apertura tip-on	E212120T
1	Pensile folding L 45 H 48 P 40,4 apertura push-pull	EPF63451/2
1	Elemento a giorno L 90 H 24 P 31 in lamiera verniciata, 3 vani	E7710017
1	Base living sospesa L 120 H 36 P 50,4 cestone, fianchi come anta	EBL76200
1	Base living L 90 H 38,5 P 50,4 cestone, 1 fianco come anta	EBL25900
1	Base living L 120 H 38,5 P 50,4 cestone, 1 fianco come anta	EBL26200
1	Top L 120 H 2,2 P 50,4 in melaminico come anta	al ml TLE225
1	Top L 210 H 2,2 P 50,4 in melaminico come anta	al ml TLE225
3	Asta appendipensili ml 2	08610501

No. of ELEMENTS	DESCRIPTION	CODE
1	Wall unit W 120 H 48 D 33,4 tip-on opening, 1 side same as door	E212120T
1	Wall unit W 120 H 48 D 33,4 tip-on opening	E212120T
1	Folding wall unit W 45 H 48 D 50,4 push-pull opening	EPF63451/2
1	Painted metal sheet open unit W 90 H 24 D 31, 3 compartments	E7710017
1	Hanging living base unit W 120 H 36 D 50,4 deep drawer, sides same as door	EBL76200
1	Living base unit W 90 H 38,5 D 50,4 deep drawer, 1 side same as door	EBL25900
1	Living base unit W 120 H 38,5 D 50,4 deep drawer, 1 side same as door	EBL26200
1	Melamine worktop W 120 H 2,2 D 50,4 same as door	per lm TLE225
1	Melamine worktop W 210 H 2,2 D 50,4 same as door	per lm TLE225
3	Wall unit fixing strip lm 2	08610501

# LIVING LI06



ANTE  
doors

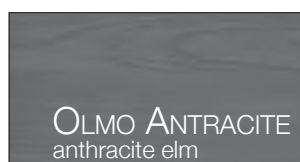

ELEMENTI TERMINALI  
end units



STRUTTURE  
carcasses

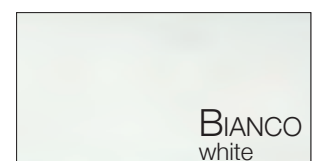
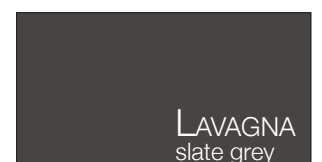

ELEMENTI A GIORNO  
open units



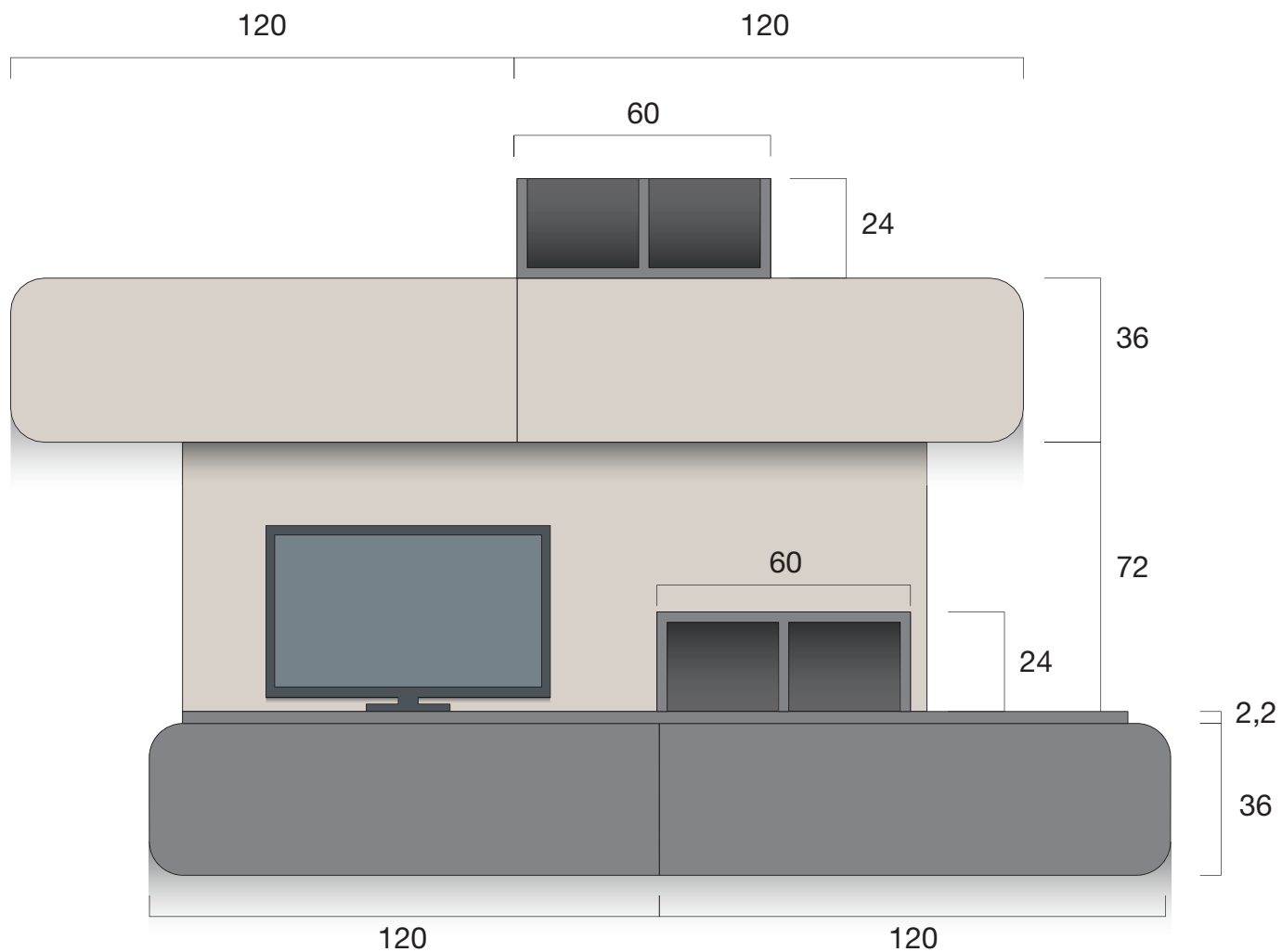

NR. ELEMENTI	DESCRIZIONE	CODICE
2	Pensile L 120 H 36 P 33,4 anta stondata apertura tip-on con terminale a giorno	ETP42951/2
2	Elemento a giorno L 60 H 24 P 31 in lamiera verniciata, 2 vani	E7710016
2	Pensile L 120 H 36 P 33,4 anta stondata apertura vasistas con terminale a giorno	ETP52951/2
1	Top L 222 H 2,2 P 33,4 in melaminico come anta	al ml TLE223
1	Schienale L 170 H 72 sp. 2,2 in melaminico come anta	al mq 094508
3	Asta appendipensili ml 2	08610501

  

No. of ELEMENTS	DESCRIPTION	CODE
2	Wall unit W 120 H 36 D 33,4 rounded edge door tip-on opening with open end unit	ETP42951/2
2	Painted metal sheet open unit W 60 H 24 D 31, 2 compartments	E7710016
2	Wall unit W 120 H 36 D 33,4 rounded edge door flap opening with open end unit	ETP52951/2
1	Melamine worktop W 222 H 2,2 D 33,4 same as door	per lm TLE223
1	Melamine back panel W 170 H 72 TH. 2,2 same as door	per m <sup>2</sup> 094508
3	Wall unit fixing strip lm 2	08610501

# LIVING LI07



ANTE  
doors

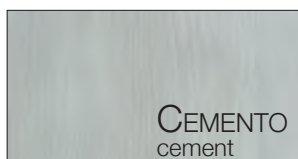

ELEMENTI A GIORNO  
open units



STRUTTURE  
carcasses

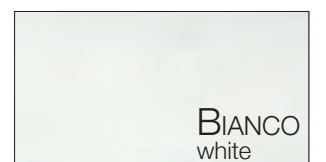
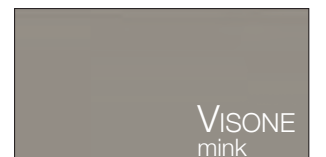

# LIVING LI07

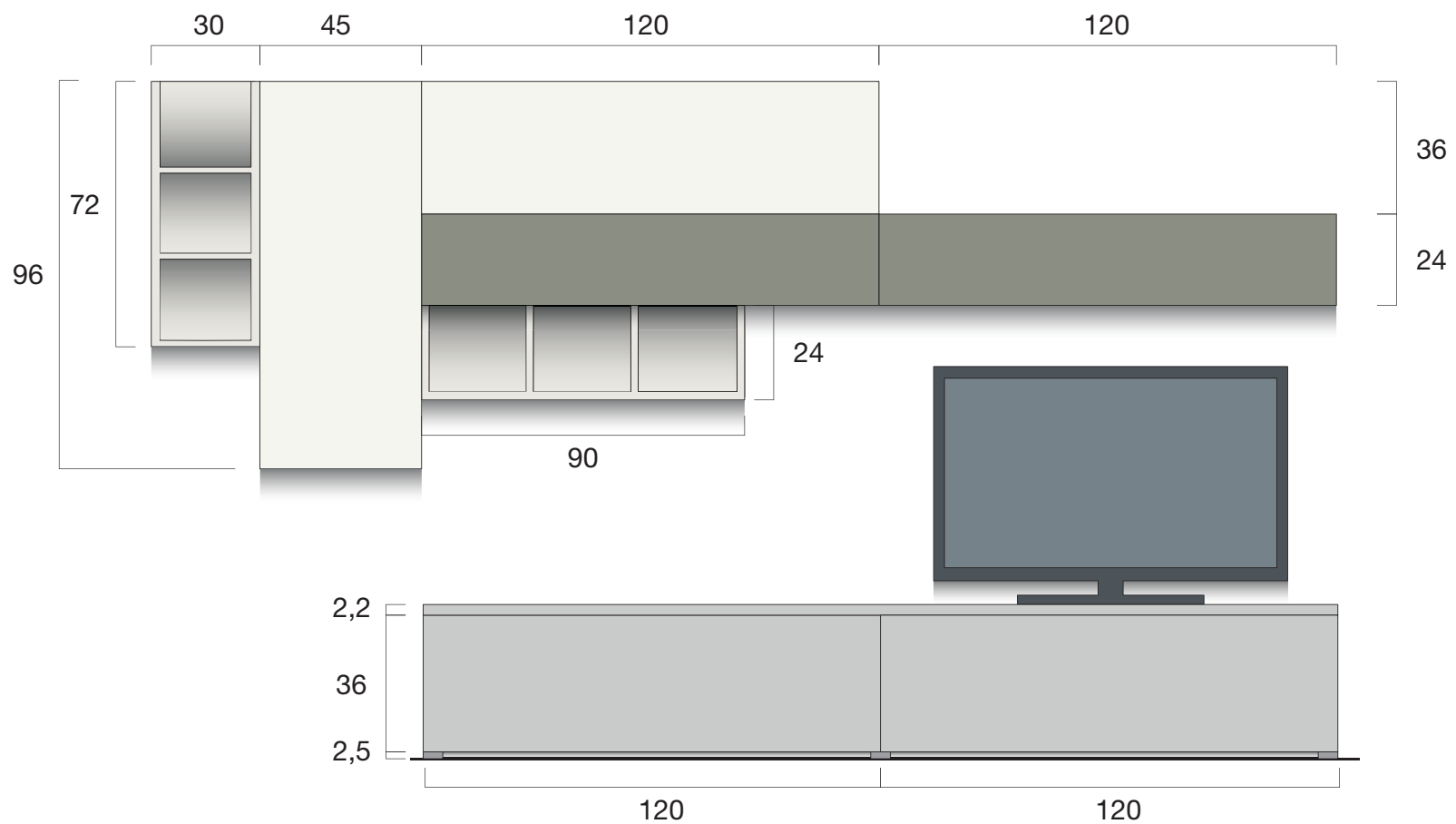

NR. ELEMENTI	DESCRIZIONE	CODICE
1	Elemento a giorno L 30 H 72 P 31 in lamiera verniciata, 3 vani	E7710040
1	Pensile L 45 H 96 P 33,4 apertura presa sul fondo, fianchi come anta	E2020451/2
1	Pensile L 120 H 36 P 33,4 apertura tip-on, 1 fianco come anta	E210120T
2	Pensile folding L 120 H 24 P 40,4 anta ribalta apertura tip-on	EPF71950
1	Elemento a giorno L 90 H 24 P 31 in lamiera verniciata, 3 vani	E7710017
2	Base living L 120 H 38,5 P 50,4 cestone apertura tip-on, 1 fianco come anta	EBL36200
1	Top L 240 H 2,2 P 50,4 in melaminico come anta	al ml TLE225
3	Asta appendipensili ml 2	08610501

No. of ELEMENTS	DESCRIPTION	CODE
1	Painted sheet metal open unit W 30 H 72 D 31, 3 compartments	E7710040
1	Wall unit W 45 H 96 D 33,4 grip on bottom opening, sides same as door	E2020451/2
1	Wall unit W 120 H 36 D 33,4 tip-on opening, 1 side same as door	E2101200
2	Folding wall unit W 120 H 24 D 40,4 flap door with tip-on opening	EPF71950
1	Painted sheet metal open unit W 90 H 24 D 31,3 compartments	E7710017
2	Living base unit W 120 H 38,5 D 50,4 deep drawer tip-on opening, 1 side same as door	EBL36200
1	Melamine worktop W 240 H 2,2 D 50,4 same as door	per lm TLE225
3	Wall unit fixing strip lm 2	08610501



# LIVING LI08



ANTE  
doors



SCHIENA  
back panel



STRUTTURE  
carcasses

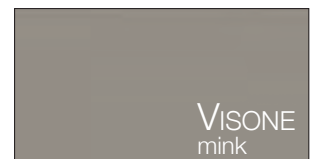

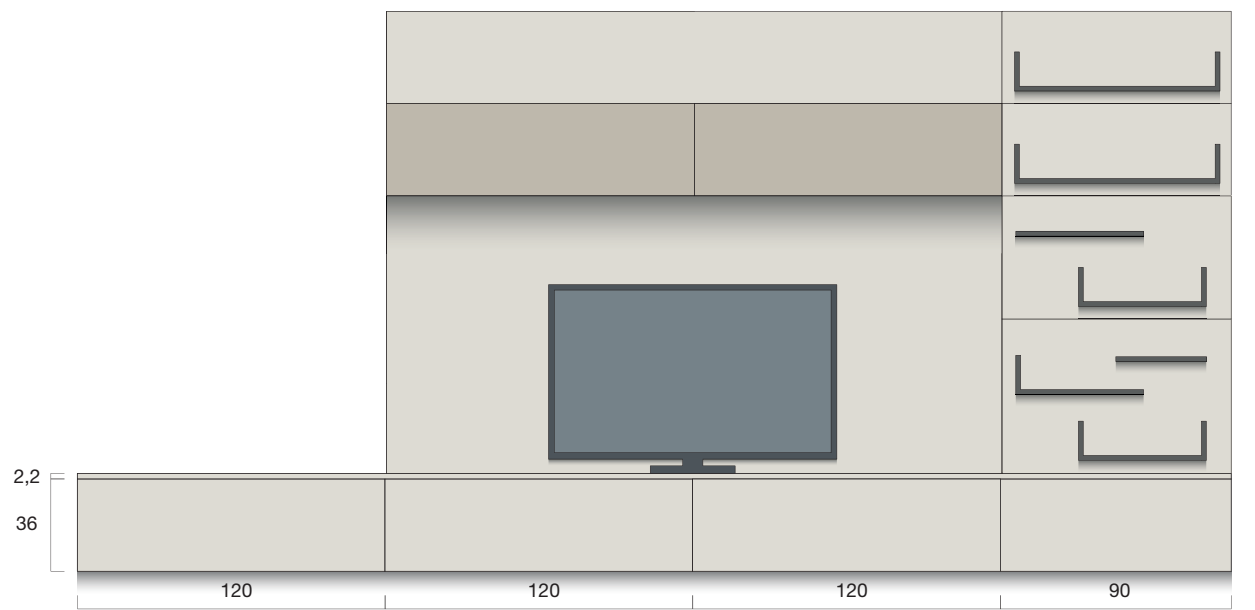

NR. ELEMENTI	DESCRIZIONE	CODICE
1	Pensile L 120 H 36 P 33,4 anta ribalta apertura tip-on	E210120T
1	Pensile L 120 H 36 P 33,4 apertura tip-on, 1 fianco come anta	E210120T
2	Base living L 120 H 36 P 50,4 cestone apertura tip-on	EBL76200
1	Base living L 120 H 36 P 50,4 cestone apertura tip-on, 1 fianco come anta	EBL76200
1	Base living L 90 H 36 P 50,4 cestone apertura tip-on, 1 fianco come anta	EBL75900
1	Schienale L 240 H 108 SP. 2,2 in melaminico come anta	al mq 094508
1	Schienale L 240 H 36 SP. 2,2 in melaminico come anta	al mq 094508
2	Mensola in lamiera a "U" con schienale in melaminico come anta L 90 H 36	E8113690
1	Mensola in lamiera a "U" con schienale in melaminico come anta L 90 H 48	E81548902
1	Mensole in lamiera con schienale in melaminico come anta L 90 H 60	E81660901
1	Top L 240 H 2,2 P 50,4 in melaminico come anta	al ml TLE225
1	Top L 210 H 2,2 P 50,4 in melaminico come anta	al ml TLE225
3	Asta appendipensili ml 2	08610501

No. of ELEMENTS	DESCRIPTION	CODE
1	Wall unit W 120 H 36 D 33,4 flap door tip-on opening	E210120T
1	Wall unit W 120 H 36 D 33,4 flap door tip-on opening, 1 side same as door	E210120T
2	Living base unit W 120 H 36 D 50,4 deep drawer tip-on opening	EBL76200
1	Living base unit W 120 H 36 D 50,4 deep drawer tip-on opening, 1 side same as door	EBL76200
1	Living base unit W 90 H 36 D 50,4 deep drawer tip-on opening, 1 side same as door	EBL75900
1	Melamine back panel W 240 H 108 Th.2,2 melamine same as door	per m <sup>2</sup> 094508
1	Melamine back panel W 240 H 36 Th.2,2 melamine same as door	per m <sup>2</sup> 094508
2	"U" steel shelf with melamine back panel W 90 H 36	E8113690
1	"U" steel shelf with melamine back panel W 90 H 48	E81548902
1	Steel shelves with melamine back panel W 90 H 60	E81660901
1	Melamine worktop W 240 H 2,2 D 50,4 same as door	per lm TLE225
1	Melamine worktop W 210 H 2,2 D 50,4 same as door	per lm TLE225
3	Wall unit fixing strip lm 2	08610501

# LIVING A SPALLA LI08



ANTA  
door



STRUTTURA  
carcass

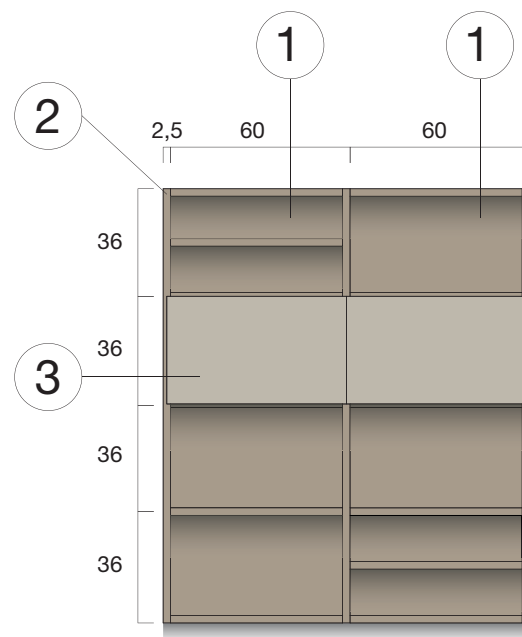

# LIVING LI09



ANTE  
doors

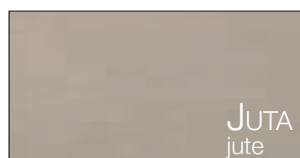

ELEMENTI A GIORNO  
open units



STRUTTURA  
carcass

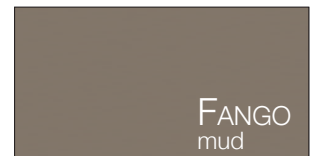

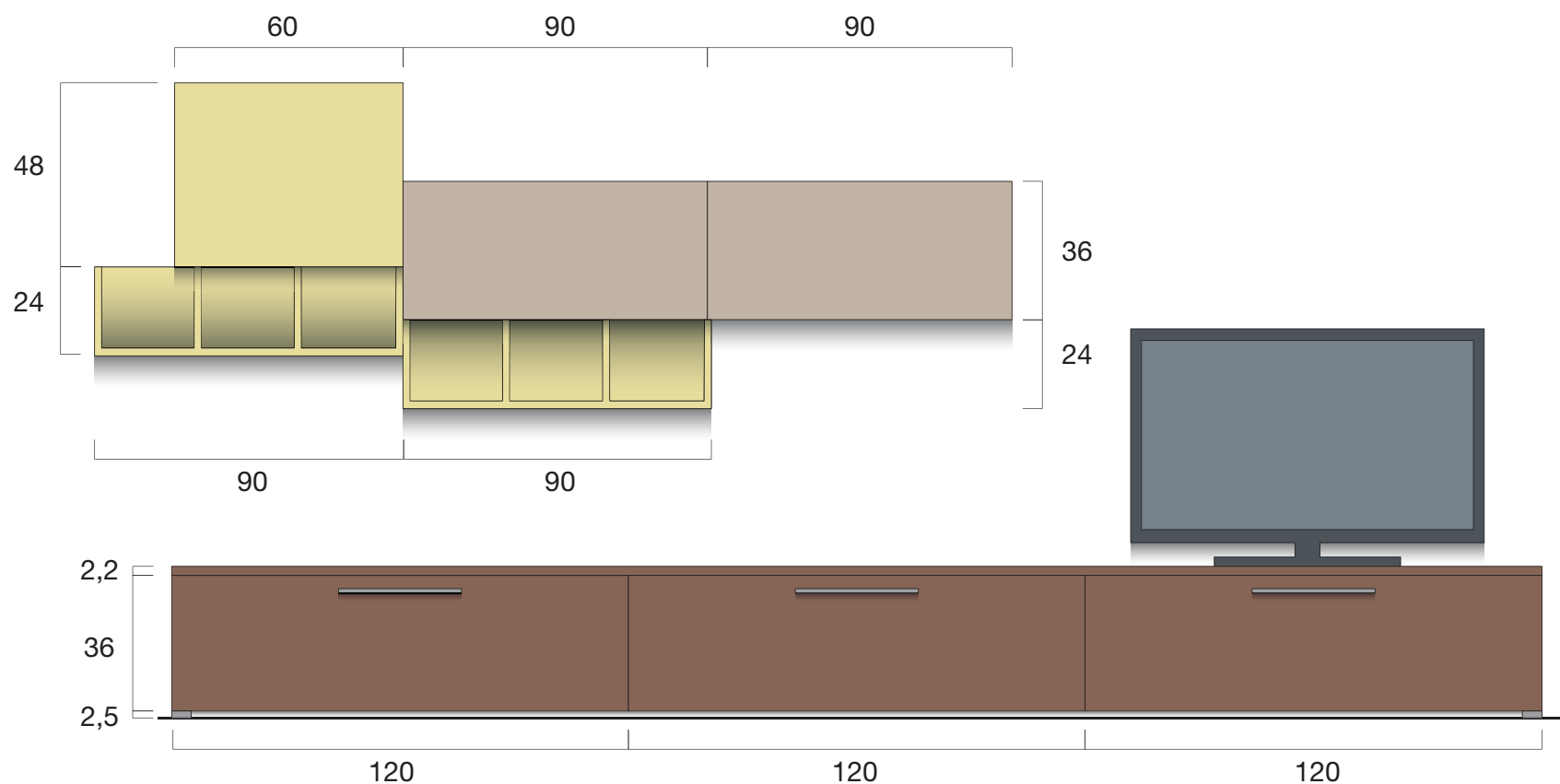

NR. ELEMENTI	DESCRIZIONE	CODICE
1	Pensile folding L 60 H 48 P 40,4 apertura push-pull	EPF63601/2
2	Elemento a giorno L 90 H 24 P 31 in lamiera verniciata, 3 vani	E7710017
1	Pensile L 90 H 36 P 33,4 apertura tip-on	E210090T
1	Pensile L 90 H 36 P 33,4 apertura tip-on, 1 fianco come anta	E210090T
2	Base living L 120 H 38,5 P 50,4 cestone, 1 fianco come anta	EBL26200
1	Base living L 120 H 38,5 P 50,4 cestone	EBL26200
1	Top L 240+120 H 2,2 P 50,4 in melaminico come anta	al ml TLE225
3	Asta appendipensili ml 2	08610501

No. of ELEMENTS	DESCRIPTION	CODE
1	Folding wall unit W 60 H 48 D 40,4 push-pull opening	EPF63601/2
2	Painted metal sheet open unit W 90 H 24 D 31, 3 compartments	E7710017
1	Wall unit W 90 H 36 D 33,4 tip-on opening	E210090T
1	Wall unit W 90 H 36 D 33,4 tip-on opening, 1 side same as door	E210090T
2	Living base unit W 120 H 38,5 D 50,4 deep drawer, 1 side same as door	EBL26200
1	Living base unit W 120 H 38,5 D 50,4 deep drawer	EBL26200
1	Melamine worktop W 240+120 H 2,2 D 50,4 same as door	per lm TLE225
3	Wall unit fixing strip lm 2	08610501



# LIVING LI10



ANTE  
doors

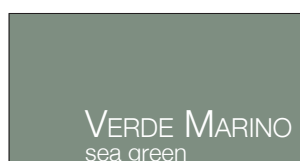

STRUTTURE  
carcasses

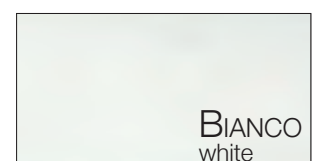
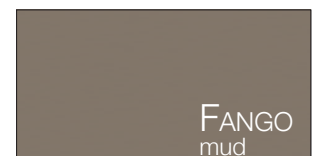

# LIVING LI10

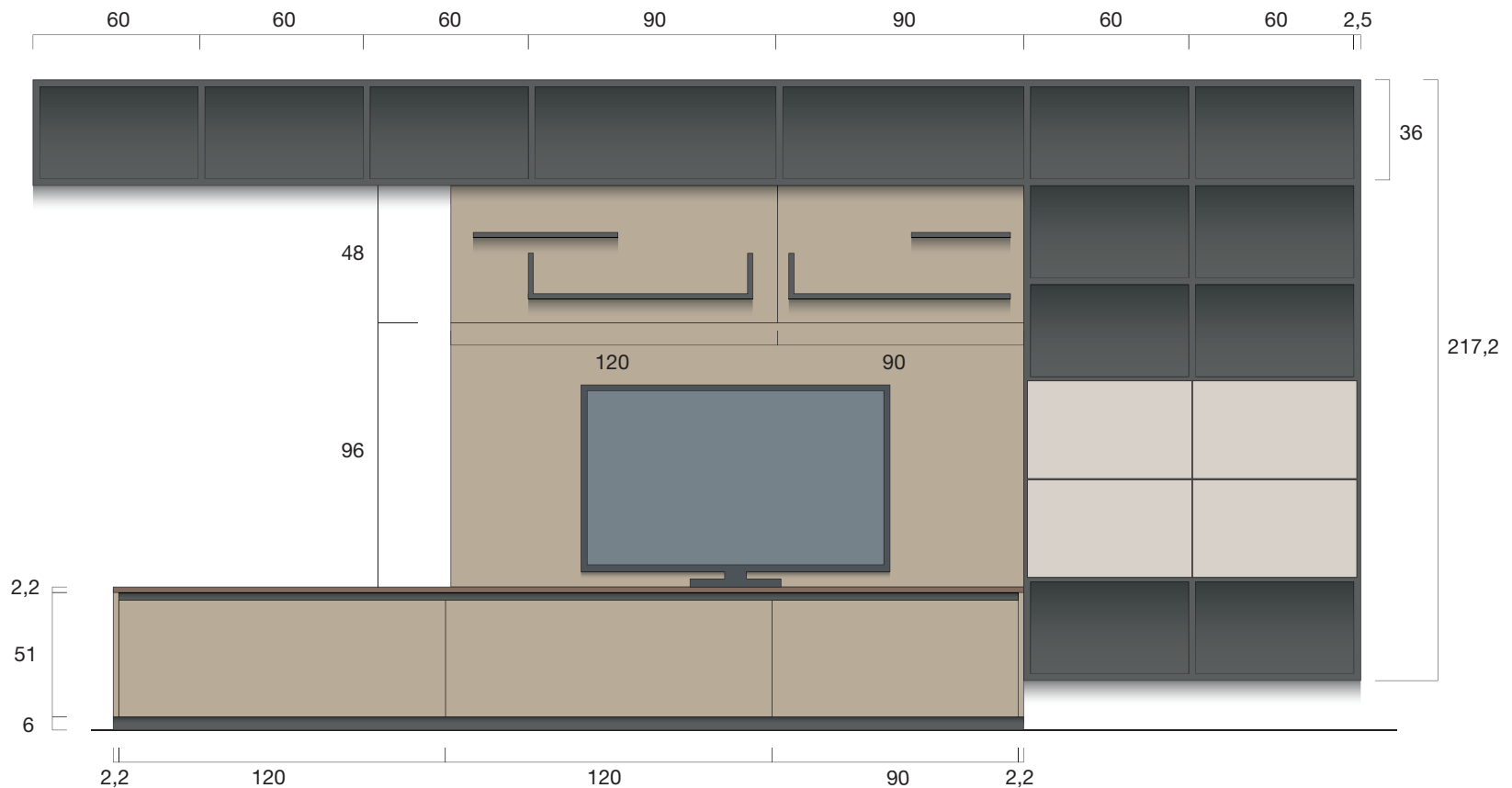

NR. ELEMENTI	DESCRIZIONE	CODICE
2	Base L 120 H 51 P 59,9 cestone	G4206200
1	Base L 90 H 51 P 59,9 cestone	G4205900
2	Fianco H 51 P 59,9 sp. 2,2 in melaminico come anta	al ml TLE226F
1	Top L 210 H 2,2 P 59,9 in melaminico come anta	al ml TLE226
1	Top L 120 H 2,2 P 59,9 in melaminico come anta	al ml TLE226
1	Schienale L 210 H 96 sp.2,2 in melaminico come anta	al mq 094508
1	Mensola in lamiera "U" con schienale in melaminico come anta L 120 H 48 tipo 5 sx	E81548122
1	Mensola in lamiera "L" con schienale in melaminico come anta L 90 H 48 tipo 4 sx	E81448122
No. of ELEMENTS	DESCRIPTION	CODE
2	Base units W 120 H 51 D 59,9 deep drawer	G4206200
1	Base units W 90 H 51 D 59,9 deep drawer	G4205900
2	Melamine side panel H 51 D 59,9 TH 2,2 same as door	per lm TLE226F
1	Melamine worktop W 210 H 2,2 D 59,9 same as door	per lm TLE226
1	Melamine worktop W 120 H 2,2 D 59,9 same as door	per lm TLE226
1	Melamine back panel W 210 H 96 TH 2,2 same as door	per m <sup>2</sup> 094508
1	"U" steel shelf with melamine back panel W 120 H 48 same as door	E81548122
1	"L" steel shelf with melamine back panel W 90 H 48 same as door	E81448122

# LIVING A SPALLA LI11



ANTA  
door

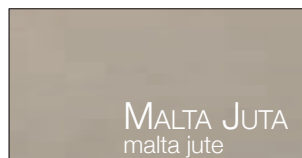

SCHIENA  
back panel



STRUTTURA  
carcass

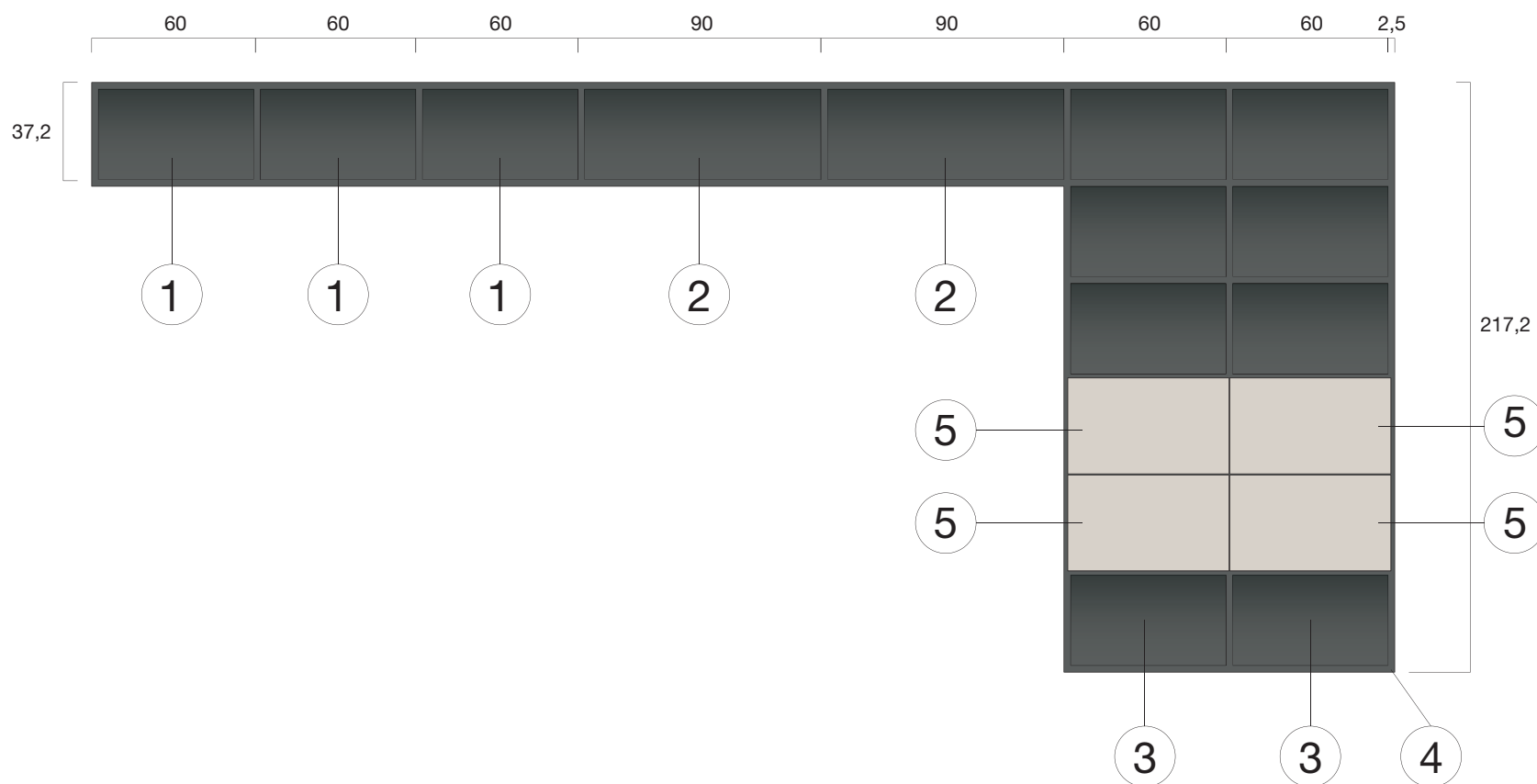
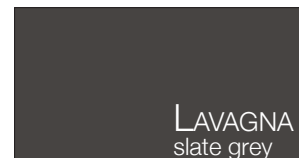



# LIVING A SPALLA LI12



ANTE  
doors

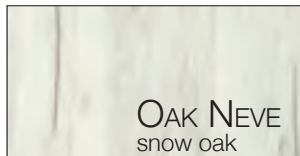

SCHIENA  
back panel



STRUTTURA  
carcass

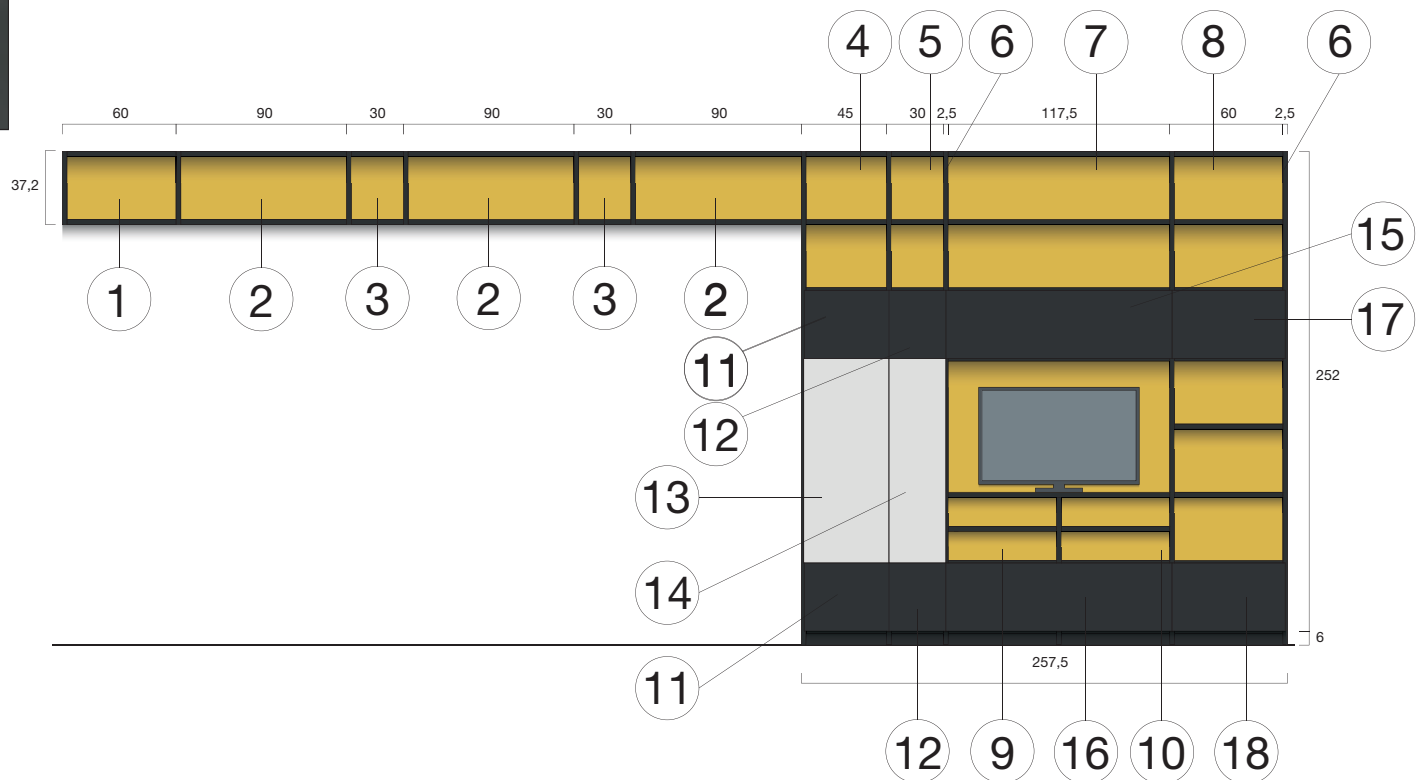
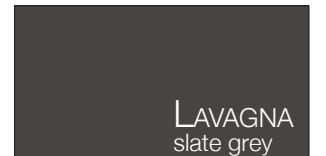

# LIVING A SPALLA BIFACCIALE LI13



ANTE  
doors

VERDE MALGA OPACO  
matt alpine green

BIANCO CRISTALLO  
cristal white

STRUTTURA  
carcass

BIANCO ASSOLUTO  
absolute white

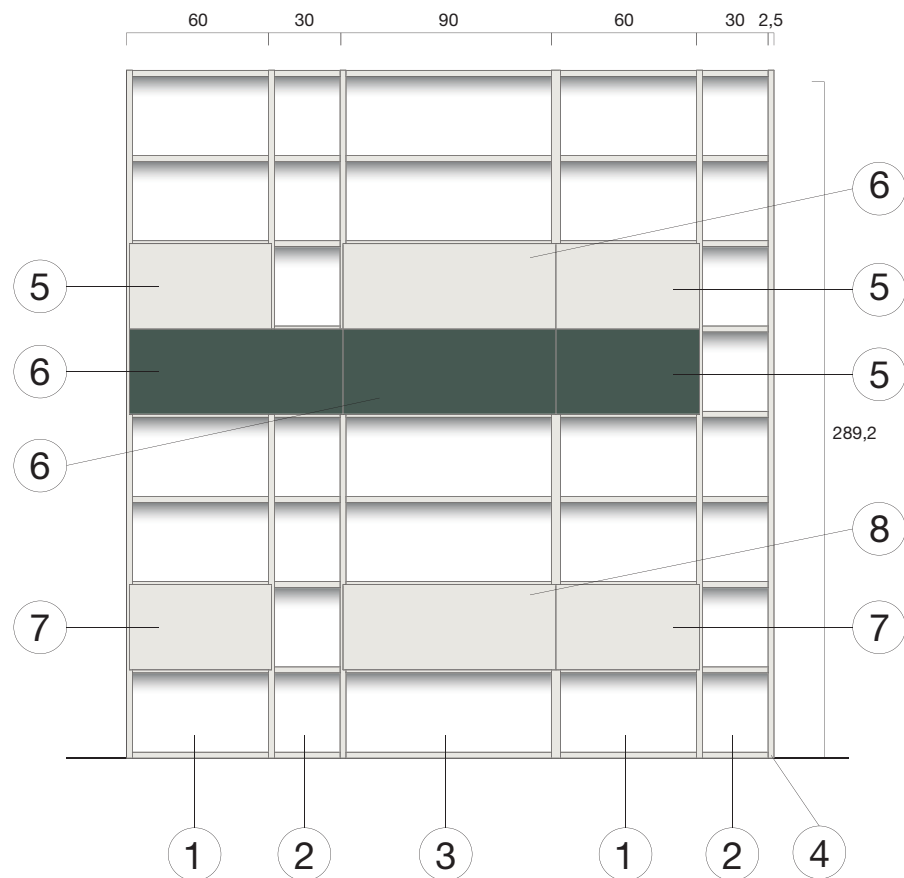



# LIVING A SPALLA LI14



STRUTTURA  
carcass



SCHIENA  
back panel

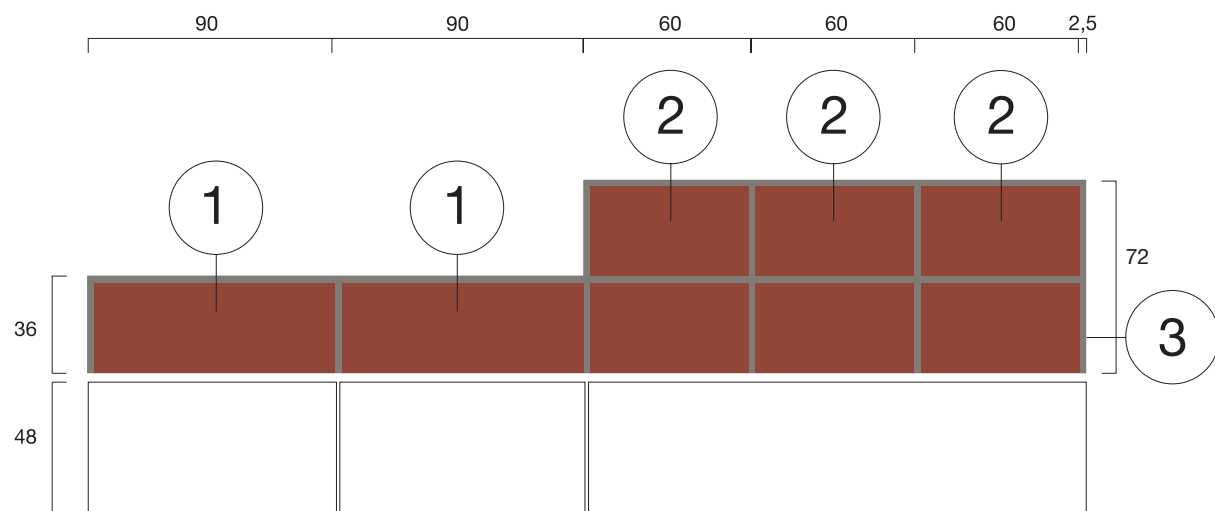



# MODULARITÀ E COMPONENTIBILITÀ MODULARITY AND FITTING SOLUTIONS

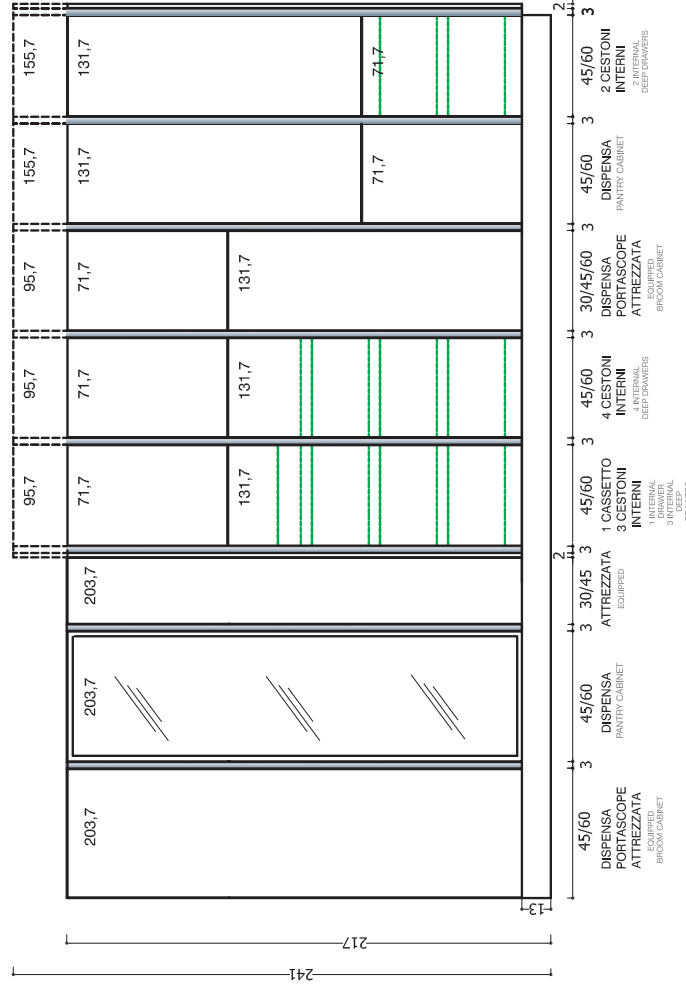
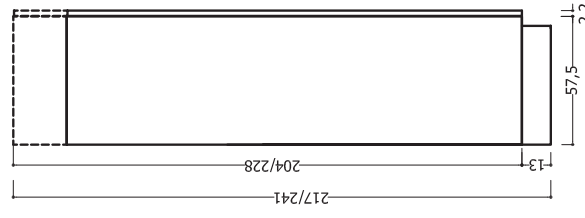
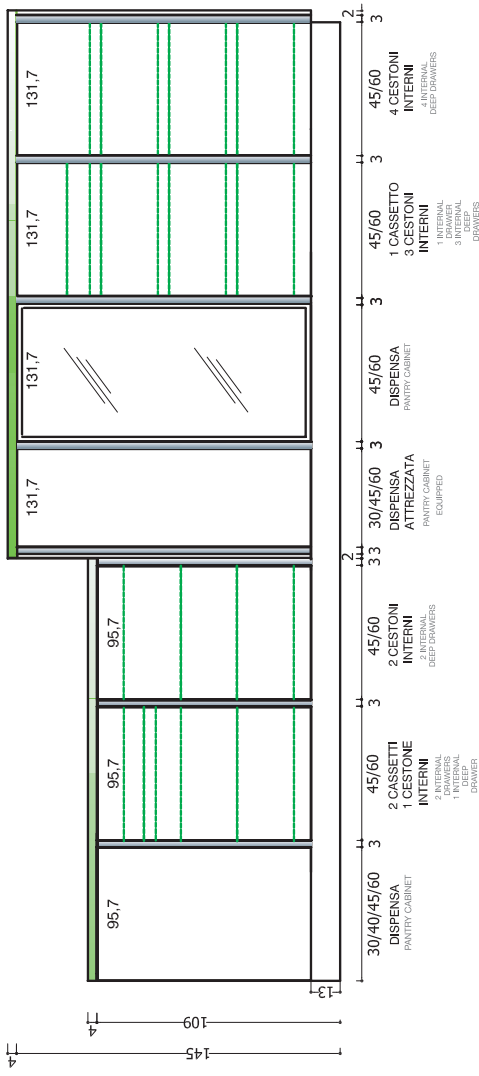
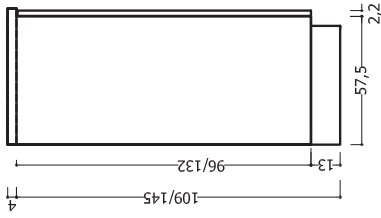



















# MODULARITÀ E COMPONENTABILITÀ MODULARITÀ AND FITTING SOLUTIONS

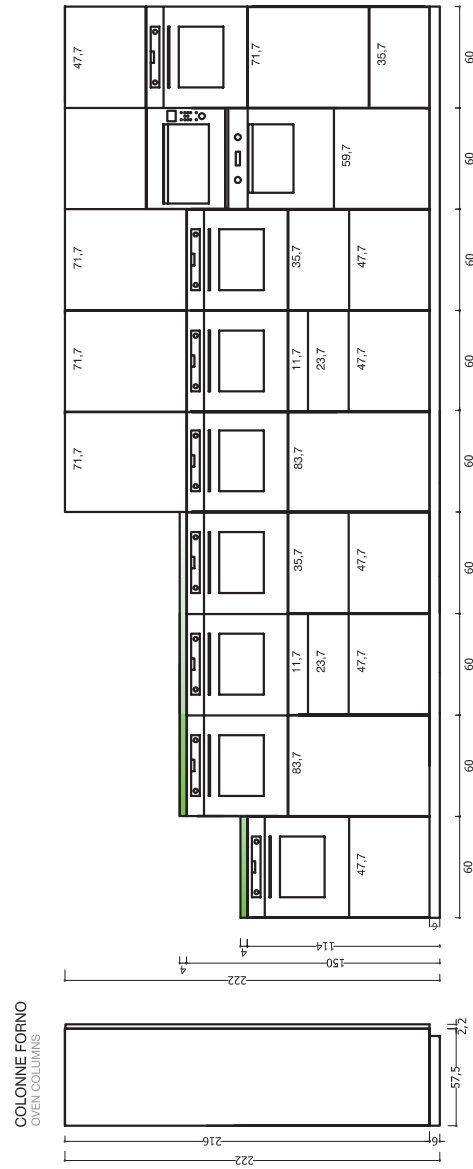
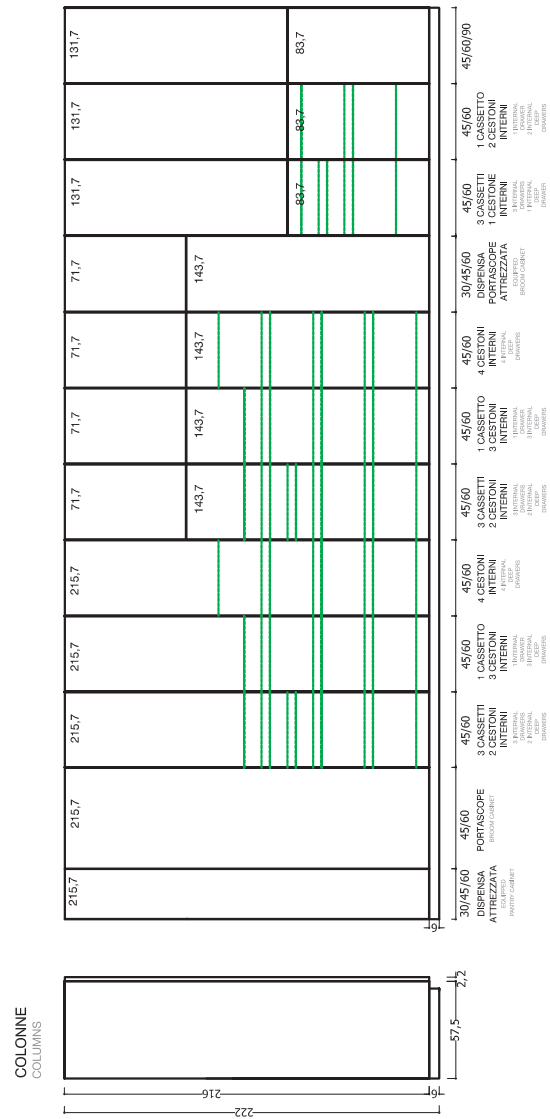
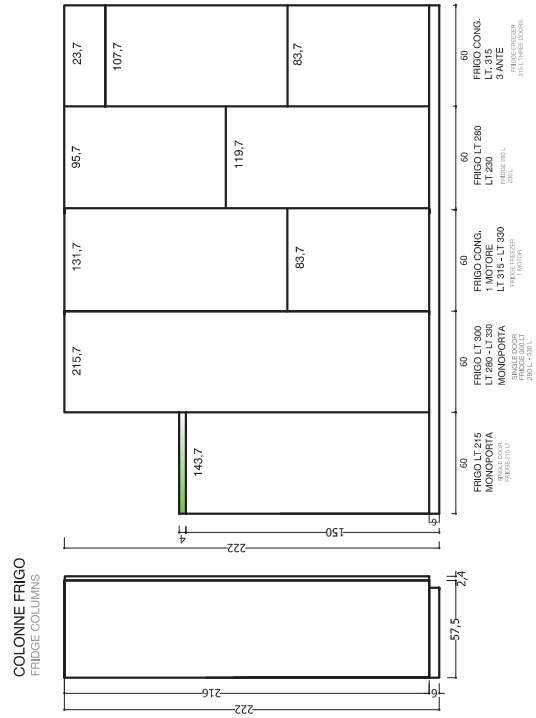

ZOCCOLO  
H 6 centimetri  
=  
più volume di  
contenimento

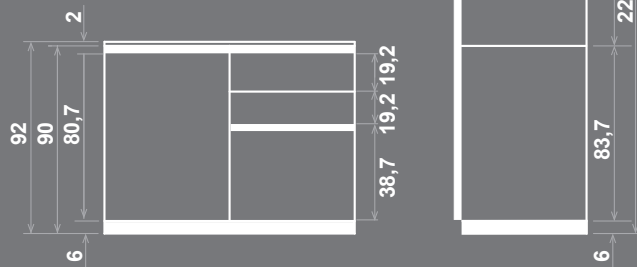

Con lo **zoccolo** ad altezza ridotta a 6 cm, si possono **guadagnare centimetri preziosi di contenimento**, dando alla cucina l'aspetto elegante di un living.

*Valuable space has been saved by lowering the plinth to 6 cm, and so the kitchen will take on a stylish look such as a living room.*





Con lo **zoccolo** ad altezza ridotta a **6 cm**, si possono **guadagnare centimetri preziosi di contenimento**, dando alla cucina l'aspetto elegante di un living.

*Valuable space has been saved by lowering the **plinth to 6 cm**, and so the kitchen will take on a stylish look such as a living room.*



strutture carcasses



bianco (opz.001)  
schiena e ripiano bianco  
(opz.001)  
white  
white back panel and shelf



conchiglia (opz.8910)  
schiena e ripiano conchiglia  
(opz.8910)  
shell  
shell back panel and shelf



lavagna (opz.9620)  
schiena e ripiano lavagna  
(opz.9620)  
slate grey  
slate grey back panel and shelf



fango (opz.8860)  
schiena e ripiano fango  
(opz.8860)  
mud  
mud back panel and shelf



visone (opz.948M)  
schiena e ripiano visone  
(opz.948M)  
mink  
mink back panel and shelf



argilla (opz.9690)  
schiena e ripiano argilla  
(opz.9690)  
clay  
clay back panel and shelf

zoccoli in alluminio H 6 aluminium plinths H 6

di serie  
standard



alluminio  
finitura brill (opz.412)  
aluminium  
brill finish (opt.412)



alluminio finitura titanio  
ossidato (opz.414)  
aluminium titanium  
oxidized finish (opt.414)



urban ossidato  
(opz.NU)  
urban oxidized finish  
(opt.NU)

zoccoli in alluminio H 6 verniciati a polvere finitura opaca  
aluminum plinths H 6 powder coated matt finish



alluminio finitura nero  
(opz.7892)  
aluminium  
black finish (opt.7892)



alluminio finitura fumo  
(opz.9531)  
aluminium  
smoke finish (opt.9531)



alluminio finitura  
bianco caldo (opz.7401)  
aluminium warm  
white finish (opt.7401)



alluminio finitura  
bianco assoluto (opz.740S)  
aluminium absolute  
white finish (opt.740S)



alluminio finitura  
acquamarina  
(opz.8323)  
aluminium aquamarine  
finish (opt.8323)



alluminio finitura giallo  
ambra (opz.8225)  
aluminium amber  
yellow finish (opt.8225)



alluminio finitura salvia  
(opz.8443)  
aluminium sage  
finish (opt.8443)



alluminio finitura rosso  
corallo (opz.8131)  
aluminium coral red  
finish (opt.8131)



alluminio finitura rosa  
quarzo (opz.8171)  
aluminium quartz  
pink finish (opt.8171)



alluminio finitura rosso  
toscano (opz.8157)  
aluminium tuscan red  
finish (opt.8157)

NEW



alluminio finitura  
grigio bromo (opz.9533)  
aluminium bromine  
grey finish (opt.9533)

NEW



alluminio finitura  
castoro (opz.8907)  
aluminium beaver  
finish (opt.8907)

NEW



alluminio finitura  
argilla (opz.9503)  
aluminium clay  
finish (opt.9503)

NEW



alluminio finitura  
cenere (opz.9547)  
aluminium ash  
finish (opt.9547)

NEW



alluminio grigio traffico  
(opz.9511)  
aluminium traffic grey  
finish (opt.9511)



alluminio finitura  
conchiglia (opz.7403)  
aluminium shell  
finish (opt.7403)



alluminio finitura  
ghisa (opz.9509)  
aluminium cast iron  
finish (opt.9509)



alluminio finitura  
giallo mais (opz.8251)  
aluminium corn yellow  
finish (opt.8251)



alluminio finitura  
grigio piombo  
(opz.9537)  
aluminium lead grey  
finish (opt.9537)



alluminio finitura  
silver dark (opz.9507)  
aluminium dark silver  
finish (opt.9507)

strutture carcasses



bianco (opz.001)  
schiena e ripiano bianco  
(opz.001)  
white  
white back panel and shelf



conchiglia (opz.8910)  
schiena e ripiano conchiglia  
(opz.8910)  
shell  
shell back panel and shelf



lavagna (opz.9620)  
schiena e ripiano lavagna  
(opz.9620)  
slate grey  
slate grey back panel and shelf



fango (opz.8860)  
schiena e ripiano fango  
(opz.8860)  
mud  
mud back panel and shelf



visone (opz.948M)  
schiena e ripiano visone  
(opz.948M)  
mink  
mink back panel and shelf



argilla (opz.9690)  
schiena e ripiano argilla  
(opz.9690)  
clay  
clay back panel and shelf

zoccoli in alluminio H 6 aluminium plinths H 6

di serie  
standard



alluminio  
finitura brill (opz.412)  
aluminium  
brill finish (opt.412)



alluminio finitura titanio  
ossidato (opz.414)  
aluminium titanium  
oxidized finish (opt.414)



urban ossidato  
(opz.NU)  
urban oxidized finish  
(opt.NU)

zoccoli in alluminio H 6 verniciati a polvere finitura opaca  
aluminum plinths H 6 powder coated matt finish

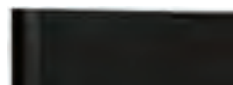

alluminio finitura nero  
(opz.7892)  
aluminium  
black finish (opt.7892)



alluminio finitura fumo  
(opz.9531)  
aluminium  
smoke finish (opt.9531)



alluminio finitura  
bianco caldo (opz.7401)  
aluminium warm  
white finish (opt.7401)



alluminio finitura  
bianco assoluto (opz.740S)  
aluminium absolute  
white finish (opt.740S)



alluminio finitura  
acquamarina  
(opz.8323)  
aluminium aquamarine  
finish (opt.8323)



alluminio finitura giallo  
ambra (opz.8225)  
aluminium amber  
yellow finish (opt.8225)



alluminio finitura salvia  
(opz.8443)  
aluminium sage  
finish (opt.8443)



alluminio finitura rosso  
corallo (opz.8131)  
aluminium coral red  
finish (opt.8131)



alluminio finitura rosa  
quarzo (opz.8171)  
aluminium quartz  
pink finish (opt.8171)



alluminio finitura rosso  
toscano (opz.8157)  
aluminium tuscan red  
finish (opt.8157)



alluminio finitura  
grigio bromo (opz.9533)  
aluminium bromine  
grey finish (opt.9533)



alluminio finitura  
castoro (opz.8907)  
aluminium beaver  
finish (opt.8907)



alluminio finitura  
argilla (opz.9503)  
aluminium clay  
finish (opt.9503)



alluminio finitura  
cenere (opz.9547)  
aluminium ash  
finish (opt.9547)



alluminio grigio traffico  
(opz.9511)  
aluminium traffic grey  
finish (opt.9511)



alluminio finitura  
conchiglia (opz.7403)  
aluminium shell  
finish (opt.7403)



alluminio finitura  
ghisa (opz.9509)  
aluminium cast iron  
finish (opt.9509)



alluminio finitura  
giallo mais (opz.8251)  
aluminium corn yellow  
finish (opt.8251)



alluminio finitura  
grigio piombo  
(opz.9537)  
aluminium lead grey  
finish (opt.9537)



alluminio finitura  
silver dark (opz.9507)  
aluminium dark silver  
finish (opt.9507)

NEW

NEW

NEW

NEW

NEW